



**Donaldson**  
FILTRATION SOLUTIONS

## **FILTERS FOR STERILE AIR, STEAM AND LIQUIDS**



# Solutions for sterile Requirements

## Donaldson - Global Partner for sterile Requirements

Donaldson is a leading global manufacturer of filtration systems. The company, founded in 1915, is strongly technology-oriented and has set itself the goal of implementing the needs of global customers



High-quality filter housings

for filtration solutions through innovative research and development. The application-oriented know-how of Donaldson relies on the global presence and the knowledge of more than 10,000 employees in more than 100 offices and manufacturing facilities.

## Reliable Process Solutions

Donaldson offers a complete filtration portfolio of innovative solutions for [air & gas](#), [steam and liquids](#). All products are designed to reach maximum purity standards and fulfil highest quality requirements.

## Reliable Product Quality

All filter elements are produced, packaged and shipped under strict controls in an exact manner and meet the quality and performance data that are stored in the product specification.

For indirect and direct food contact according to FDA CFR - Code of Federal Regulations, Title 21	<b>FDA</b>
For indirect and direct food contact in accordance with Regulation (EC) No 1935/2004	
3-A Sanitary Standards for the United States	
Manufactured according to DIN EN ISO 9001	
Manufactured according to the specifications of the Pressure Equipment Directive 97/23/EC	<b>CE</b>

## Product Portfolio

Air and gas filters	Steam filters	Liquid filters
Housings	Housings	Housings
Membrane filters	Sintered steel filters	Membrane filters
Depth filters	Steel-mesh filters	Depth filters

The illustrated colour scheme displays the various applications for a quick and easy overview on the following pages.

## Typical Application Areas



Dairies



Water & Soft Drinks



Breweries



Wineries



Pharmaceutical



Food

# Cost-effective Solutions in Industrial Quality

## Air and Gas Filter Housings

### High-quality Stainless Steel Housings in Industrial Quality



P-EG housing

P-EG filter housings have been developed for the purification of compressed air. Due to the optimised construction, they offer low differential pressures at high flow rates. The filter

housings are suitable for operating flow rates of 60 m<sup>3</sup>/h to 19,200 m<sup>3</sup>/h.

P-EG housings comply with the applicable guidelines:	
Compliant according to	<b>FDA</b> 
Manufactured by	 <b>CE</b>

### Technical Data P-EG Housings

Size	Capacity [m <sup>3</sup> /h] at 7 bar operating pressure*	Element	Connection size	Connections			Materials										
				BSP standard thread	Flange	Welded ends	Filter housings	Housing gasket									
Single																	
0006	60	03/10	G 1/4"	Standard	Available	Available	Stainless steel 1.4301 (304) or 1.4404 (316L)	EPDM									
0009	90	04/10	G 3/8"														
0012	120	04/20	G 1/2"														
0018	180	05/20	G 3/4"														
0027	270	05/25	G 1"														
0036	360	07/25	G 1 1/4"														
0048	480	07/30	G 1 1/2"														
0072	720	10/30	G 2"														
0108	1080	15/30	G 2"														
0144	1440	20/30	G 2 1/2"														
0192	1920	30/30	G 3"														
0288	2880	30/50	G 3"														
Multiple																	
0432	4320	3x20/30	DN 100	-	Standard	Available	Stainless steel 1.4301 (304) or 1.4404 (316L)	Blue Gard Style 3000									
0576	5760	3x30/30	DN 100														
0768	7680	4x30/30	DN 150														
1152	11520	6x30/30	DN 150														
1536	15360	8x30/30	DN 200														
1920	19200	10x30/30	DN 200														
Size	Surface finish		Dimensions** [mm]		Volume [L]	Weight** [kg]	Maximum operating pressure [bar]	Maximum operating temperature [°C]									
	Inside	Outside	Height	Width													
Single																	
0006	Etched and passivated Ra < 1.6	Etched, passivated and polished Ra < 1.6	215	108	0.55	1.70	16	-25/+150									
0009			245	108	0.65	1.90											
0012			245	108	0.65	1.90											
0018			270	125	0.75	2.00											
0027			300	125	1.00	2.60											
0036			350	140	1.25	3.00											
0048			380	170	2.30	4.30											
0072			455	170	3.30	4.80											
0108			580	170	4.30	5.30											
0144			762	216	8.00	9.00											
0192	1015	216	11.10	10.80													
0288	1035	240	16.50	16.20													
Multiple																	
0432	Etched and passivated Ra < 1.6	Etched and passivated Ra < 1.6	1090	410	36.00	43.00	10	-25/+150									
0576			1350	410	45.00	44.00											
0768			1410	480	77.00	70.00											
1152			1460	540	110.00	80.00											
1536			1600	660	190.00	135.00											
1920			1600	660	190.00	135.00											
Operating pressure (bar)		1	2	3	4	5	6	7	8	9	10	11	12	13	14	15	16
Conversion factor		0.25	0.36	0.50	0.60	0.75	0.90	1.00	1.10	1.20	1.40	1.50	1.60	1.75	1.90	2.00	2.10

\* [m<sup>3</sup>/h] at 1 bar at 20 °C, for other operating pressures see table of conversion factors

\*\* Dimensions are valid for the standard connection

Larger housings are available on request

# Economical Solutions in Sanitary Quality

## Air and Gas Filter Housings

### High Quality Stainless Steel Housings in Sanitary Quality



PG-EG housing

PG-EG stainless steel housings are used for the purification of compressed air and other technical gases. Combined with the different filter elements they provide an optimised solution for nearly any application. The standard model series PG-EG (Single and Multiple) each consists of six different housing sizes for operating flow rates of 7.5 m<sup>3</sup>/h to 270 m<sup>3</sup>/h and for operating flow rates of 540 m<sup>3</sup>/h to 2,700 m<sup>3</sup>/h (at 1 bar

absolute). Donaldson PG-EG sanitary filter housings (Single, clamp connection) are 3-A certified as standard.

absolute). Donaldson PG-EG sanitary filter housings (Single, clamp connection) are 3-A certified as standard.

PG-EG housings comply with the applicable guidelines:	
Compliant according to	
Manufactured according to	

### Technical Data PG-EG Housings

Size	Capacity [m <sup>3</sup> /h] at operating pressure of 1 bar at 20 °C*	Element	Connection size	Connections			Materials											
				Clamp	Flange	Welded ends	Filter housings	Housing gasket										
Single																		
0006	7,5	03/10	DN 10	Standard	Available	Available	Stainless steel 1.4404 (316L)	EPDM										
0018	22,5	05/20	DN 10															
0032	45	05/30	DN 25															
0072	90	10/30	DN 40															
0144	180	20/30	DN 50															
0192	270	30/30	DN 65															
Multiple																		
0432	540	3x20/30	DN 100	-	Standard	Available	Stainless steel 1.4301 (304)	Blue Gard Style 3000										
0576	810	3x30/30	DN 100															
0768	1080	4x30/30	DN 150															
1152	1620	6x30/30	DN 150															
1536	2160	8x30/30	DN 200															
1920	2700	10x30/30	DN 200															
Multiple																		
Size	Surface finish	Dimensions** [mm]		Volume [L]	Weight** [kg]	Maximum operating pressure [bar]	Maximum operating temperature [°C]											
		Height	Width															
Single																		
0006	Etched, passivated and electro-polished, Ra < 0.8 inside and outside	267	120	0.60	1.50	16	-25/+150											
0018		319	120	0.80	1.70													
0032		379	162	1.80	2.10													
0072		506	162	3.20	2.90													
0144		789	206	5.40	4.50													
0192		1043	206	7.40	5.70													
Multiple																		
0432	Etched, passivated and electro-polished, Ra < 0.8 inside and outside	1155	410	36.00	43.00	10	-25/+150											
0576		1410	410	45.00	44.00													
0768		1475	480	77.00	70.00													
1152		1530	540	110.00	80.00													
1536		1665	660	190.00	135.00													
1920		1665	660	190.00	135.00													
Operating pressure (bar)		0	1	2	3	4	5	6	7	8	9	10	11	12	13	14	15	16
Conversion factor		1	2	3	4	5	6	7	8	9	10	11	12	13	14	15	16	17

\* Please use the conversion factor for other operating pressures

\*\* Dimensions are valid for the standard connection

\*\*\* The 3-A certification is valid for Single-PG-EG standard housings with clamp connection  
Larger housings are available on request

# Innovative, sterile Aeration and Deaeration

## Air and Gas Filter Housings

### Filter Housings for the Aeration and Deaeration of Storage Tanks and Bulk Tanks



P-BE housing

Filter housings for venting of product series P-BE are used to ensure 100% sterility in the storage of pharmaceutical products, containers of demineralised water, food, chemicals or the deaeration of fermenters. The user-friendly two-piece housing has a splash protection to help prevent liquids coming into contact with the filter medium.

P-BE housings comply with the applicable guidelines:

Compliant according to



Manufactured according to



Filter housings for the aeration on storage tanks

### Technical Data P-BE Housings

Size	Capacity [m³/h]*		Element	Connection size	Connections			Materials	
	Δp = 20 mbar	Δp = 40 mbar			Milk pipe DIN 11851	Flange	Clamp	Filter housings	Fasteners
Single									
0006	4.5	9	03/10	DN 32	Standard	Available	Available	Stainless steel 1.4301 (304) or 1.4404 (316L) on request	Stainless steel 1.4301 (304) or 1.4404 (316L) on request
0027	12	24	05/25	DN 40					
0032	17	35	05/30	DN 50					
0072	35	70	10/30	DN 50					
0144	70	140	20/30	DN 80					
0192	105	210	30/30	DN 80					
Multiple									
0432	210	420	3x20/30	DN 100	Available	Standard	Available	Stainless steel 1.4301 (304) or 1.4404 (316L) on request	Stainless steel 1.4301 (304) or 1.4404 (316L) on request
0576	315	630	3x30/30	DN 100					
0768	420	840	4x30/30	DN 150					
1152	630	1260	6x30/30	DN 150					
1536	840	1680	8x30/30	DN 200					
1920	1050	2010	10x30/30	DN 200					
Size	Dimensions [mm]**		Weight [kg]**	Maximum operating temperature [°C]					
	Height	Diameter							
Single									
0006	110	85.00	1.50	+200					
0027	168	104.00	2.20						
0032	186	114.30	2.40						
0072	312	114.30	3.30						
0144	550	154.00	9.20						
0192	805	154.00	11.60						
Multiple									
0432	670	219.10	14.50	+200					
0576	925	219.10	17.50						
0768	950	273.00	30.00						
1152	950	323.90	30.00						
1536	960	406.40	43.00						
1920	960	406.40	43.00						

\* [m³/h] relative to 1 bar at 20 °C

\*\* Dimensions are valid for the standard connection

# Sterile Filtration of Air and Gases

## Air and Gas Filter Elements

### Sterile Filter LifeTec™ (P)-SRF C/V/X

The new LifeTec (P)-SRF filter in the versions C (=Compressed Air), V (=Venting), and X (=Extreme) is mainly used for safe sterile air and gas filtration. The sterile filters meet the high demands of the food and beverage industry as well as the pharmaceutical industry and works reliably even under extreme operating conditions. High filtration rates, e.g. for bacteria, viruses, and particles of down to 3 nm, increase product and process integrity. The sturdy construction of the filter with its stainless steel liners allows for a high number of steam sterilization cycles as well as for sterilization processes, using VPHP and ozone. It is ideal for fermentation applications.

Temperature resistance and mechanical stability ensure a high degree of operational safety, reducing the total cost of ownership. This helps to avoid production downtimes and reduces maintenance costs.

### Outstanding Features

- High filtration rate:  
LRV for bacteria and MS2 coliphage up to > 9,  
for nano-scaled particles up to > 10
- Suitable for sterilization, using hydrogen peroxide (VPHP) and ozone
- Low differential pressure at high flow rates
- Filter elements are reverse-flow sterilizable
- For indirect food contact according to CFR Title 21 & 1935/2004/EC
- Excellent dewetting characteristics
- Mechanical stability for high operational safety

Suitable for temperatures up to +200 °C

Filter element	LifeTec (P)-SRF C
	
Filter media	Borosilicate
Retention rates [µm]	0.2 µm; sterile LRV > 9
Support liner	1.4301 (304)
End caps	1.4301 (304)
O-rings (others on request)	Silicone
Element size	03/10; 04/10; 04/20; 05/20; 05/25; 07/25; 05/30; 07/30; 10/30; 15/30; 30/30
Connections	uf, P7
Recommended housings	PG-EG, P-EG, P-BE
Conformity	
Operating temperature	Up to + 200 °C
Maximum differential pressure	5 bar (in flow direction)
Application examples	Sterile filtration of compressed air and gases, tank ventilation



Food



Dairies



Breweries





























Pharmaceutical



Chemical

# When it has to be pure and sterile

## Air and Gas Filter Elements

Filter element	LifeTec (P)-GSL N	LifeTec (P)-SRF V	LifeTec (P)-SRF X	LifeTec PT N
				
<b>Filter media</b>	Stainless steel fiber or stainless steel mesh 1.4301 (304)	Borosilicate	Pleated PTFE membrane	Pleated PTFE membrane
<b>Retention rates [µm]</b>	1; 5; 25; 50; 100; 250 absolute*	0.2; sterile LRV > 9	0.2; sterile LRV > 9	0.2; sterile LRV > 7
<b>Support liner</b>	1.4301 (304)	1.4301 (304)	1.4301 (304)	Polypropylene
<b>End caps</b>	1.4301 (304)	1.4301 (304)	1.4301 (304)	Polypropylene
<b>O-rings (others on request)</b>	EPDM	Silicone	Silicone	EPDM
<b>Element sizes</b>	03/10; 04/10; 04/20; 05/20; 07/20; 05/30; 07/30; 10/30; 15/30; 30/30; 30/50	03/10; 04/10; 04/20; 05/20; 05/25; 07/25; 05/30; 07/30; 10/30; 15/30; 30/30; 30/50	03/10; 04/10; 04/20; 05/20; 05/25; 07/25; 05/30; 07/30; 10/30; 15/30; 30/30	10"; 20"; 30"; 40"
<b>Connections</b>	uf, P7	uf, P7	uf, P7	P2, P3, P7, P8, P9, uf, DOE
<b>Recommended housings</b>	P-EG, PG-EG	PG-EG, P-EG	PG-EG, P-EG, P-BE	PG-EG, P-EG, P-BE
<b>Conformity</b>	<b>FDA</b> 	<b>FDA</b> 	<b>FDA</b> 	<b>FDA</b> 
<b>Operating temperature</b>	Up to +200 °C	Up to +200 °C	Up to +200 °C	Up to +82 °C
<b>Maximum differential pressure</b>	10 bar	5 bar (regardless of the flow direction)	5 bar (regardless of the flow direction)	5.5 bar (<+35 °C), 2 bar (<+80 °C) in flow direction
<b>Application examples</b>	Prefilter for compressed air and gases, tank ventilation	Venting of tanks which are cleaned under using CIP reagents	Sterile filtration of compressed air and gases under extreme application and sterilization conditions	Sterile filtration of compressed air and gases
<b>Industries</b>	 Food  Paints/Coatings  Environment  Pharmaceutical  Chemical	 Food  Dairies  Breweries  Pharmaceutical  Chemical	 Food  Dairies  Breweries  Pharmaceutical  Chemical	 Food  Water & Soft Drinks  Dairies  Pharmaceutical  Chemical

\* Retention rates in air

# Steam Sterilisation Instructions for Air Filters

## Work Flow: Sterilisation Instructions for Air Filter in Flow Direction

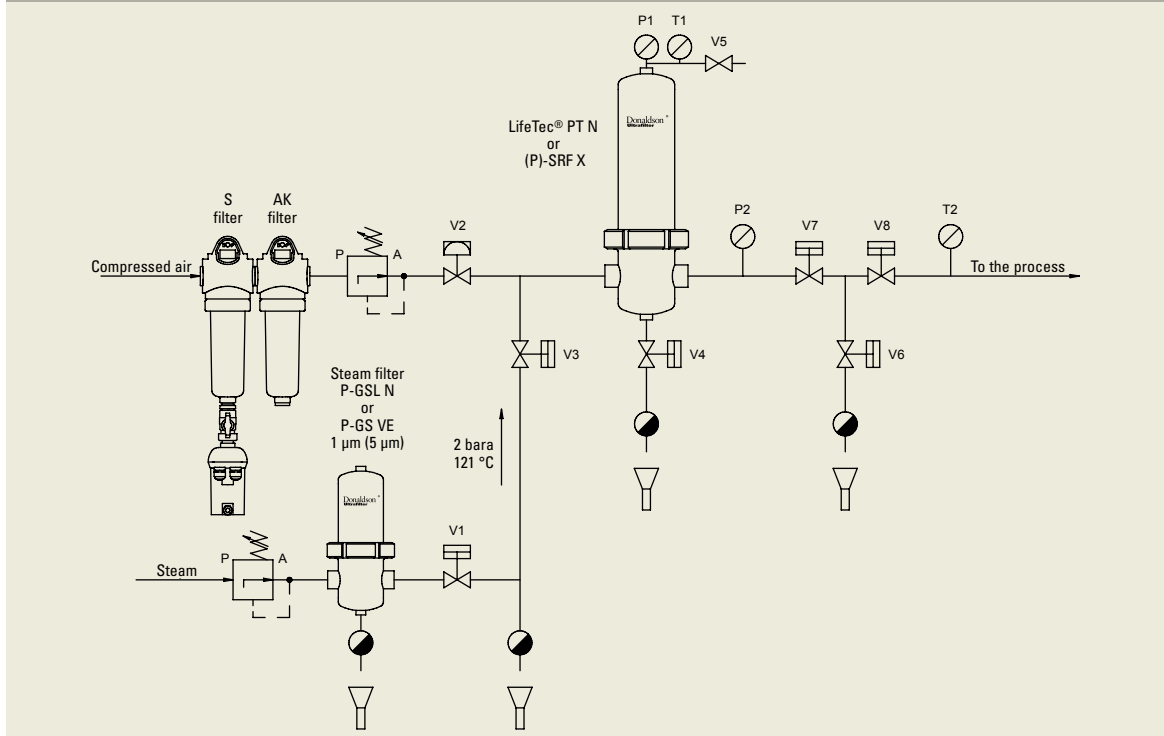

(1) Open valves V4, V5, V6, and V7.

(2) Open valve V1 and allow the steam condensate to drain until the steam trap below valve V3 closes.

(3) Slowly open V3 allowing steam into the system: this will flow across the filters and through valve V4 and V5. This will allow the heating of the housing, the filters and associated piping without generating a significant differential pressure across the filters.

(4) When 'live' steam flows from valve V5, close valve V5. This will direct the steam through the heated filter.

(5) Observe the pressure gauges P1 and P2, control the steam flow rate at valve V3 and set the sterilisation steam pressure to approx. 300 mbar above the required saturated steam pressure (P1).

(6) Ensure the differential pressure across the filter does not exceed 0.2 to 0.3 bar g.

(7) When the steam trap below valve V6 closes, the steam pressure will begin to rise.

(8) Ensure the steam pressure/temperature does not exceed the maximum allowable pressure/temperature for the cartridge type being steamed. If reading from pressure gauges it is recommended the maximum steam pressure is 3.0 bar g in the forward direction.

(9) Steam sterilise the cartridges for the time specified ensuring the conditions stated in steps 5 to 7 are followed.

(10) On completion of the Sterilisation-In-Place (SIP) cycle, close V4, V6, V3 and V1 in that order.

(11) Fully open V5 to flash-dry the filter (or step 12).

(12) Open V2 to allow compressed air into the system. The air pressure should be no more than 0.5 bar g above the steam pressure.

(13) Allow the system to cool for 15 minutes, then close V5 (flash-dry only).

See our sterilisation guide for additional information!



# Steam Sterilisation Instructions for Air Filters

## Work Flow: Sterilisation Instructions for Air Filters in Reverse Direction

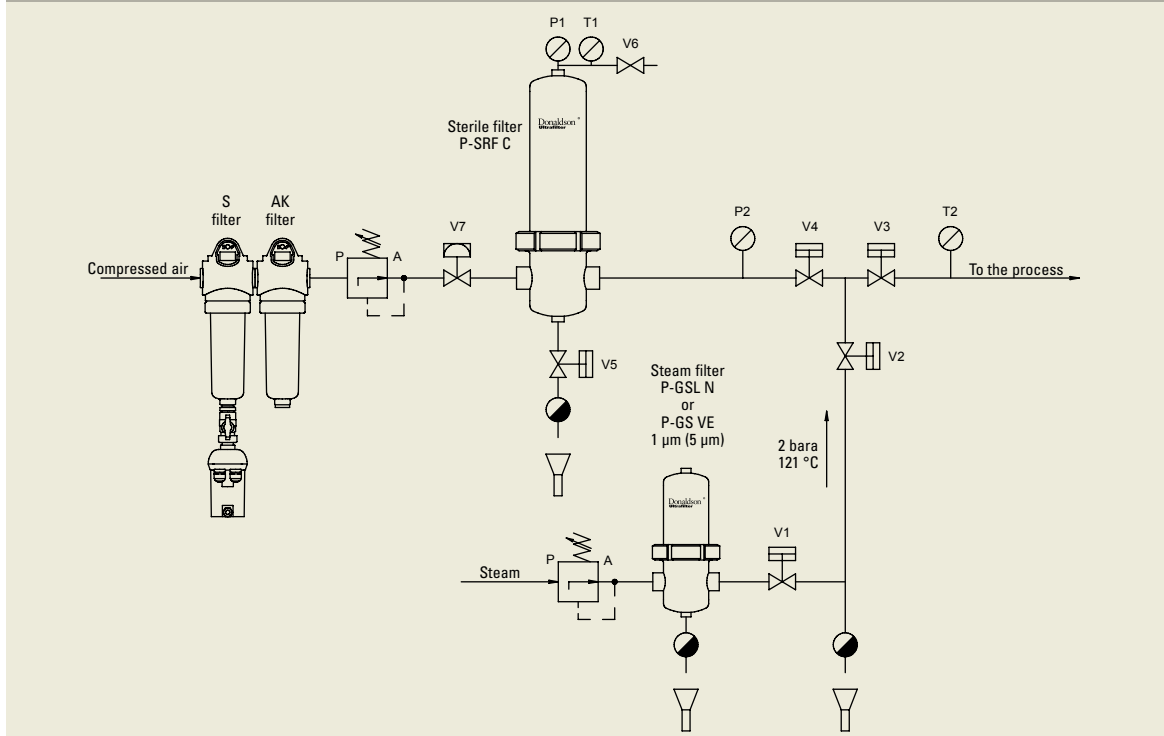

(1) Open valves V4, V5 and V6.

(2) Open valve V1 and allow the steam condensate to drain until the steam trap below valve V2 closes.

(3) Slowly open V2 allowing steam into the system.

(4) Observe the pressure gauges P1 and P2 and control the steam flow rate at valve V2 to ensure the differential pressure across the filter does not exceed 0.1 bar g\*. If it exceeds 100 mbar stop the sterilisation procedure and rectify the cause of the differential pressure before proceeding with the sterilisation routine.

(5) When 'live' steam flows from valve V6, close valve V6. When the steam trap below valve V5 closes, the steam pressure will begin to rise.

(6) Ensure steam pressure/temperature does not exceed the maximum allowable pressure/temperature for the cartridge type being steamed. Continue to monitor the differential pressure using gauges P1 and P2. If it exceeds 100 mbar stop the sterilisation procedure.

(7) On completion of the sterilisation cycle time, close V4, V2, V1 in that order.

(8) Rapidly open V6 to flash dry the filter (or step 9).

(9) Open V7 slowly to allow air into the system. The pressure of the air should be no more than 0.5 bar g above the steam pressure.

(10) Allow the system to cool for 15 minutes then close V6 (flash-dry only).

Comments for Sterilisation Instructions for Air Filters:

A double downstream valve is recommended so that under the cartridge steaming protocol the valves sealing faces of V7 can be effectively sterilised. The sealing valve faces of V8 can be similarly sterilised when the tank is steamed. When steam sterilizing the tank, V7 would be closed and V6 and V8 open. Normally the tank would be steamed separately before steaming the filter. If the filter is steamed before steaming the tank it is recommended that valve V7 is closed in the post Sterilisation-In-Place settings to maintain sterility. The valve V7 must be closed during Step 9. Valve V7 should be installed horizontally and valve V6 / steam trap installed immediately downstream of V7. All drains should be fitted vertically to allow liquid removal.

\* Pressure gauge display  
See our sterilisation guide for additional information!

# Housings for high Flow Rates

## Steam Filter Housings

### High-quality Stainless Steel Housings in Industrial Quality





P-EG housing

Together with the (P)-GS VE and the LifeTec (P)-GSL N filter elements, the Donaldson P-EG filter housings are used in a variety of steam filtration applications. Equipped with

various connections, the P-EG housings are designed for low differential pressures and high flow rates.

P-EG housings comply with the applicable guidelines:

Compliant according to	<b>FDA</b> 
Manufactured according to	 <b>CE</b>

### Technical Data P-EG Housings

Size	Capacity [kg/h] at 2 bar abs. at 121 °C saturated steam	Element	Connection size	Connections			Materials	
				BSP standard thread	Flange	Welded ends	Filter housing	Housing gasket
Single								
0006	7.5	03/10	G 1/4"	Standard	Available	Available	Stainless steel 1.4301 (304) or 1.4404 (316L)	EPDM
0009	11.25	04/10	G 3/8"					
0012	15.0	04/20	G 1/2"					
0018	22.5	05/20	G 3/4"					
0027	33.75	05/25	G 1"					
0036	45	07/25	G 1 1/4"					
0048	60	07/30	G 1 1/2"					
0072	90	10/30	G 2"					
0108	135	15/30	G 2"					
0144	180	20/30	G 2 1/2"					
0192	240	30/30	G 3"					
0288	360	30/50	G 3"					
Multiple								
0432	540	3x20/30	DN 100	-	Standard	Available	Stainless steel 1.4301 (304) or 1.4404 (316L)	Blue Gard Style 3000
0576	720	3x30/30	DN 100					
0768	960	4x30/30	DN 150					
1152	1440	6x30/30	DN 150					
1536	1920	8x30/30	DN 200					
1920	2400	10x30/30	DN 200					
Size	Surface finish		Dimensions* [mm]		Volume [L]	Weight* [kg]	Maximum operating pressure [bar]	Maximum operating temperature [°C]
	Inside	Outside	Height	Width				
Single								
0006	Etched and passivated Ra < 1.6	Etched, passivated and polished Ra < 1.6	215	108	0.55	1.70	16	-25/+150
0009			245	108	0.65	1.90		
0012			245	108	0.65	1.90		
0018			270	125	0.75	2.00		
0027			300	125	1.00	2.60		
0036			350	140	1.25	3.00		
0048			380	170	2.30	4.30		
0072			455	170	3.30	4.80		
0108			580	170	4.30	5.30		
0144			762	216	8.00	9.00		
0192			1015	216	11.10	10.80		
0288	1035	240	16.50	16.20				
Multiple								
0432	Etched and passivated Ra < 1.6	Etched and passivated Ra < 1.6	1090	410	36.00	43.00	10	-25 /+150
0576			1350	410	45.00	44.00		
0768			1410	480	77.00	70.00		
1152			1460	540	110.00	80.00		
1536			1600	660	190.00	135.00		
1920			1600	660	190.00	135.00		

\* Dimensions are valid for the standard connection  
Larger housings are available on request

# and for low Differential Pressures

## Steam Filter Housings

### High Quality Stainless Steel Housings in Sanitary Quality



PG-EG housing

PG-EG stainless steel housings are used for steam filtration at the highest hygienic requirements. In combination with the various Donaldson filter elements, they offer the optimal solution for each application. Donaldson PG-EG sanitary filter housings (Single, clamp connection) are 3-A certified as standard, can be equipped with a variety of connections and are

PG-EG stainless steel housings are used for steam filtration at the highest hygienic requirements. In combination with the various Donaldson filter elements, they offer the optimal solution for each application. Donaldson PG-EG sanitary filter housings (Single, clamp connection) are 3-A certified as standard, can be equipped with a variety of connections and are

available in 12 different sizes. In addition, the entire series is designed for a low differential pressure and for a high throughput.

PG-EG housings comply with the applicable guidelines:	
Compliant according to	 
Manufactured according to	 

### Technical Data PG-EG Housings

Size	Capacity [kg/h] at 2 bar abs. at 121 °C saturated steam	Element	Connection size	Connections			Materials	
				Clamp	Flange	Welded ends	Filter housing	Housing gasket
Single								
0006	7.5	03/10	DN 10	Standard	Available	Available	Stainless steel 1.4404 (316L)	EPDM
0018	22.5	05/20	DN 10					
0032	45	05/30	DN 25					
0072	90	10/30	DN 40					
0144	180	20/30	DN 50					
0192	270	30/30	DN 65	Multiple				
0432	540	3x20/30	DN 100	-	Standard	Available	Stainless steel 1.4301 (304)	Blue Gard Style 3000
0576	810	3x30/30	DN 100					
0768	1080	4x30/30	DN 150					
1152	1620	6x30/30	DN 150					
1536	2160	8x30/30	DN 200					
1920	2700	10x30/30	DN 200					
Size	Surface finish	Dimensions* [mm]		Volume [L]	Weight* [kg]	Maximum operating pressure [bar]	Maximum operating temperature [°C]	
		Height	Width					
Single								
0006	Etched, passivated and electro-polished, Ra < 0.8 inside and outside	267	120	0.60	1.50	16	-25/+150	
0018		319	120	0.80	1.70			
0032		379	162	1.80	2.10			
0072		506	162	3.20	2.90			
0144		789	206	5.40	4.50			
0192		1043	206	7.40	5.70			Multiple
0432	Etched, passivated and electro-polished, Ra < 0.8 inside and outside	1155	410	36.00	43.00	10	-25/+150	
0576		1410	410	45.00	44.00			
0768		1475	480	77.00	70.00			
1152		1530	540	110.00	80.00			
1536		1665	660	190.00	135.00			
1920		1665	660	190.00	135.00			

\* Dimensions are valid for the standard connection

\*\* The 3-A certification is valid for Single-PG-EG standard housings with clamp connections  
Larger housings are available on request

# Steam Filtration with high Flow Rates

## Steam Filter Elements



### Steam Filter LifeTec™ (P)-GSL N

The LifeTec (P)-GSL N filter element removes contaminants such as particles, abrasion of valve, seatings and seals as well as rust. An improved steam quality ensures longer service life of the filters to be sterilised and therefore increases the efficiency of the entire process. In addition, the LifeTec (P)-GSL N filter element is a particularly efficient filtration product since the filter medium can be regenerated by ultrasonic bath or by back washing. This is especially important where there is a particularly high particle load. The pleated stainless steel filter media provides high particle or dirt-holding capacity and a high flow rate at low differential pressures.

#### Outstanding Features

- High dirt-holding capacity at a low differential pressure and a high flow rate
- Can be regenerated by back washing and ultrasonication
- Retention rate > 99.996 at 0.01 µm
- Suitable for temperatures from -20 °C up to +200 °C
- Also available as 5 µm grade for culinary steam
- Suitable for food contact use according to CFR Title 21 & 1935/2004/EC

Retention rate down to 0.01 µm in saturated steam

Filter element	LifeTec (P)-GSL N
	
Filter media	Stainless steel fiber or stainless steel mesh 1.4301 (304)
Retention rates [µm]	1 nominal; 5; 25; 50; 100; 250 absolute*
Support liner	1.4301 (304)
End caps	1.4301 (304)
O-rings (others on request)	EPDM
Element sizes	03/10; 04/10; 04/20; 05/20; 07/20; 05/30; 07/30; 10/30; 15/30; 30/30; 30/50
Connections	uf, P7
Recommended housings	P-EG, PG-EG
Conformity	<b>FDA</b> 
Operating temperature	Up to +200 °C
Maximum differential pressure	10 bar
Application examples	Filter for liquids, gases and steam

\* Retention rates in steam



Food



Dairies



Paints and Coatings















Pharmaceutical



Industrial Machinery

# High Process Safety

## Steam Filter Elements

Filter element	(P)-GS VE	(P)-GS N
		
<b>Filter media</b>	Sintered stainless steel 1.4404 (316L)	Stainless steel fibre or stainless steel mesh 1.4301 (304)
<b>Retention rates [µm]</b>	1; 5; 25 absolute for gases, nominal for steam	1; 5; 25 absolute for steam and gases
<b>Support liners</b>	–	1.4301 (304)
<b>End caps</b>	1.4301 (304)	1.4301 (304)
<b>O-rings (others on request)</b>	EPDM	EPDM
<b>Element sizes</b>	03/10; 04/10; 04/20; 05/20; 05/25; 07/25; 05/30; 07/30; 10/30; 15/30; 30/30; 30/50	03/10; 04/20; 05/20; 05/30; 07/30; 10/30; 15/30; 30/30
<b>Connections</b>	uf, P7	uf, P7
<b>Recommended housings</b>	P-EG, PG-EG	P-EG, PG-EG
<b>Conformity</b>	<b>FDA</b> 	–
<b>Operating temperature</b>	Up to +200 °C	Up to +160 °C
<b>Maximum differential pressure</b>	5 bar (regardless of the flow direction)	5 bar (in flow direction)
<b>Application examples</b>	Filter for gases and steam	Filter for gases and steam
<b>Industries</b>	 Food  Dairies  Pharmaceutical  Chemical	 Paints/Coating  Environment  Industrial Machinery  Automotive  Chemical

## General Guidelines for the Design of Steam Filtration Installations

The type of the steam filter and the retention rate to be selected depends on the quality of the steam which is required for the specific application. To prevent rapid clogging of the steam filter, it is important to consider the particle load in the pipes. This may require the use of pre- and fine filters.

In addition, the flow rate of the steam in an installation should not exceed 25 m/s. In special circumstances, velocities up to 40 m/s are okay, but the resulting turbulent currents and higher differential pressures must be taken into account.

The differential pressure in a new steam filter installation should be within a range of 0.1 bar to 0.3 bar. Higher temperatures (> 150 °C) require special higher temperature O-rings.

## Choice of Steam Filters

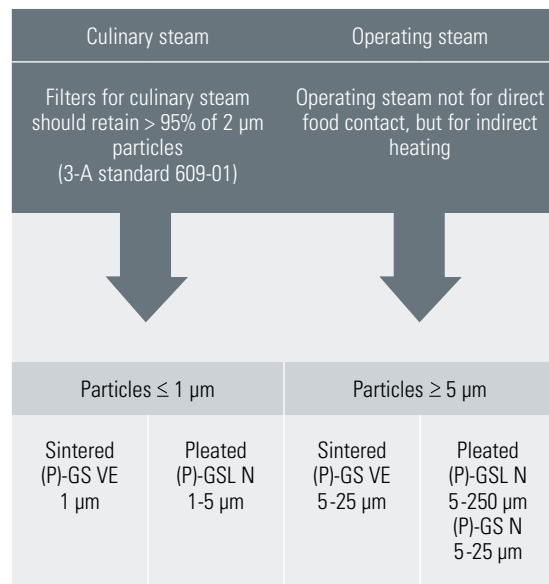

# Recommendations for the Design of Steam Filter Systems

## (1) Recommendations Installation

- The flow through the membrane filter during the steam sterilisation may only occur from the upstream side (see figure on page 8).
- In a steam sterilisation, the flow through a sterile depth filter is possible from the upstream as well as in the reverse process (see figure on page 9).
- The pressure difference between the filter inlet and outlet should not exceed 0.3 bar g (pressure gauge reading). The steam flow rate in the filter element must be limited to a minimum value. The temperature and differential pressure during sterilisation must be measured and controlled.
- A vent valve must be mounted at the top of the housing, since the system must be vented prior to sterilisation. Residual air trapped in the system causes a decrease in temperature in the filter housing, which can prevent a complete destruction of micro-organisms.

## (2) Steam Pretreatment Recommendations

- Vapour filters protect the sterile filter efficiently against damage e.g. corrosion particles.
- Filtered boiler feed water is a prerequisite for particulate-controlled steam.
- The steam generator must be serviced regularly. The systems (pipelines, etc.) should preferably be made of stainless steel.

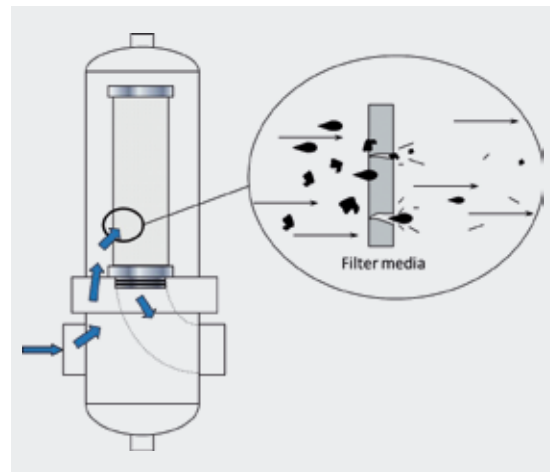

At a vapour velocity of 20 m/sec in the pipe, particle or particles (e.g. corrosion particles) impact the sterile filter medium at a speed of 72 km/h. (30 m/sec correspond to a speed of 108 km/h).

## (3) Recommendations Condensate Removal

- Condensate traps or drains in the housing should be installed upstream and downstream on the lowest points in the overall system.
- All piping must be installed in the flow direction at a slight slope (1-2%), so that steam condensate can collect into a condensate drain/trap by gravity.
- Filter housings must be installed vertically (with the housing opening facing down) so that the condensate cannot accumulate inside the housing/filter element.
- Filters must be installed at the top of tanks if they must be sterilised simultaneously with the tank.
- After a SIP process, as much steam as possible must be drained from the system to prevent the development of large quantities of condensate.
- The cooling of the filter elements according to a SIP process must be controlled so that these do not become 'blinded' by the condensate (especially important for hydrophobic gas filters).

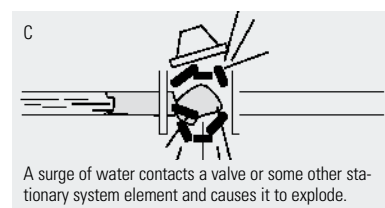
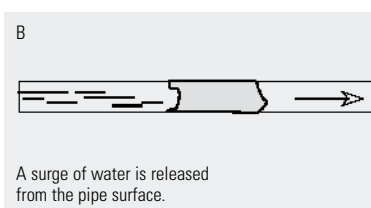
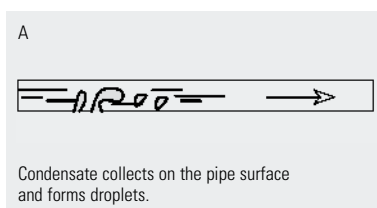

Condensate must be prevented in the entire system and removed immediately to prevent the risk of exploding valves.

# Economical Filtration Solutions

## Liquid Filter Housings

### Stainless Steel Housings for Liquids



PF-EG housing

PF-EG stainless steel housings (PF-EG Standard series and PF-EG Superplus series) have been developed for the filtration of liquids. In combination with various Donaldson code 7 filter cartridges all liquid filter housings can be used within different application areas. The standard series PF-EG Single consists of six different housing sizes for flow rates from 3 to 75 l/min – the series PF-EG Multiple of 17 housing sizes for flow rates of 150 to 3,000 l/min. Donaldson PF-EG Superplus

filter housings (Single, clamp connection) are certified 3-A as standard.

PF-EG housings comply with the applicable guidelines:	
Compliant according to	
Manufactured according to	

### Technical Data PF-EG Housings

Size	Capacity [l/min.]* 5 µm	Element	Connection size	Dimensions** [mm]		Volume [L]	Weight** [kg]	Maximum operating pressure [bar]		Maximum operating temperature [°C]
				Height	Width			For fluids of 50 °C	For saturated steam of 150 °C	
Single										
0003	3	03/10	DN 10	280	140	0.30	1.20	10	3.7	-25/+150
0008	8	05/20	DN 10	333	140	0.40	1.40			
0012	12	5/3 Code 7	DN 25	406	250	1.50	4.40			
0025	25	10/3 Code 7	DN 25	541	250	2.50	5.10			
0050	50	20/3 Code 7	DN 25	795	250	4.50	6.70			
0075	75	30/3 Code 7	DN 25	1049	250	6.60	7.70			
Multiple										
0320	150	3x20/3 Code 7	DN 40	1065	426	12.6	19.4	10	4	-25/+150
0330	225	3x30/3 Code 7	DN 40	1314	426	17.8	21.4			
0340	300	3x40/3 Code 7	DN 40	1564	426	23.1	23.4			
0520	250	5x20/3 Code 7	DN 50	1075	490	20	20			
0530	375	5x30/3 Code 7	DN 50	1325	490	29.1	22			
0540	500	5x40/3 Code 7	DN 50	1575	490	38.2	24			
0820	400	8x20/3 Code 7	DN 50	1096	516	35.5	30			
0830	600	8x30/3 Code 7	DN 50	1345	516	49.7	33			
0840	800	8x40/3 Code 7	DN 50	1596	516	63.9	36			
1230	900	12x30/3 Code 7	DN 65	1430	627	88	66			
1240	1200	12x40/3 Code 7	DN 65	1680	627	112	70			
1830	1350	18x30/3 Code 7	DN 65	1450	644	115	68			
1840	1800	18x40/3 Code 7	DN 65	1700	644	146	74			
2430	1800	24x30/3 Code 7	DN 65	1470	698	151	105			
2440	2400	24x40/3 Code 7	DN 65	1720	698	190	114			
3030	2250	30x30/3 Code 7	DN 80	1500	820	235	109			
3040	3000	30x40/3 Code 7	DN 80	1750	820	293	117			
Connections			Materials				Surface finish			
Standard		Superplus		Filter housing		Housing gasket		Standard		Superplus
Single										
Milk pipe		Clamp		Stainless steel 1.4404 (316L)		EPDM gaskets (other gaskets on request)		Interior and exterior stained & passivated		Interior and exterior electro-polished Ra < 0.8
Multiple										
Milk pipe		Milk pipe		Stainless steel 1.4404 (316L)		EPDM gaskets (other gaskets on request)		Interior and exterior stained & passivated		Interior and exterior electro-polished Ra < 0.8









































\* Capacity based on water

\*\* Dimensions valid for milk pipe connections

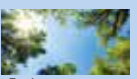
\*\*\* The 3-A certification is valid for the PF-EG Superplus Single housing with clamp connection; PF-EG Multiple housings in 3-A quality are also available on request. Larger housings are available on request.

# Best Quality for your Process



































## Liquid Filter Elements

Category	Sterile Membrane Filters		Absolute Membrane Filters	Absolute Depth Filters		
Filter element	LifeTec PT N	LifeTec PES WN	LifeTec PES BN A	LifeTec PP 100 N	LifeTec PP 100 CN	(P)-SIM N
						
<b>Filter media</b>	Pleated PTFE membrane	Pleated polyethersulfone membrane	Pleated polyethersulfone membrane	Pleated polypropylene	Pleated polypropylene	Stainless steel fibre or stainless steel mesh 1.4301 (304)
<b>Retention rates [µm]</b>	0.2 sterile LRV > 7	0.2 sterile; 0.45; 0.6 LRV > 7	0.45 absolute	0.6; 0.8; 1; 2.4; 5; 10 absolute	1 absolute, Crypto retentive acc. to NSF/ANSI 53 §7	1; 5; 25; 50; 100; 250 absolute
<b>Support liner</b>	Polypropylene	Polypropylene	Polypropylene	Polypropylene	Polypropylene	1.4301 (304)
<b>End caps</b>	Polypropylene	Polypropylene	Polypropylene	Polypropylene	Polypropylene	1.4301 (304)
<b>O-rings (others on request)</b>	EPDM	EPDM	EPDM	EPDM	EPDM	EPDM
<b>Element sizes</b>	10"; 20"; 30"; 40"	10"; 20"; 30"; 40"	10"; 20"; 30"; 40"	10"; 20"; 30"; 40"	10"; 20"; 30"; 40"	10"; 20"; 30"
<b>Connections</b>	P2, P3, P7, P8, P9, uf, DOE	P2, P3, P7, P8, P9, uf, DOE	P2, P3, P7, P8, P9, uf, DOE	P2, P3, P7, P8, P9, uf, DOE	P2, P3, P7, P8, P9, uf, DOE	P7, uf
<b>Recommended housings</b>	PF-EG	PF-EG	PF-EG	PF-EG	PF-EG	PF-EG
<b>Conformity</b>	<b>FDA</b> 	<b>FDA</b> 	<b>FDA</b> 	<b>FDA</b> 	<b>FDA</b> 	<b>FDA</b> 
<b>Operating temperature</b>	Up to +82 °C	Up to +82 °C	Up to +82 °C	Up to +82 °C	Up to +82 °C	Up to +150 °C
<b>Maximum differential pressure</b>	5.5 bar (<+35 °C), 2 bar (<+80 °C) in flow direction	5.5 bar (<+35 °C), 2 bar (<+80 °C) in flow direction	5.5 bar (<+35 °C), 2 bar (<+80 °C) in flow direction	5.5 bar (<+35 °C), 2 bar (<+80 °C) in flow direction	5.5 bar (<+35 °C), 2 bar (<+80 °C) in flow direction	5 bar (in flow direction)
<b>Application examples</b>	Sterile filtration of gases and liquids	Sterile/final filter for water and soft drinks	Final filter for beer and wine	Fine filter for liquids	Fine filter for liquids	Fine filter for liquids
<b>Industries</b>	 Food	 Food	 Breweries	 Breweries	 Breweries	 Food
	 Dairies	 Beverages	 Wineries	 Wineries	 Wineries	 Beverages
	 Pharmaceutical	 Water & Soft Drinks	 Water & Soft Drinks	 Environment	 Environment	 Paints & Coatings
	 Chemical	 Chemical	 Chemical	 Water & Soft Drinks	 Water & Soft Drinks	 Environment
		 Dairies		 Chemical	 Dairies	 Pharmaceutical
				 Chemical		 Chemical



# Hygiene at the highest Level

## Liquid Filter Elements

Category	Absolute Depth Filters	Nominal Depth Filters			
Filter element	PP-FC100 	LifeTec PP N 	LifeTec PP-TF N 	LifeTec (P)-GSL N 	PP-FC 
Filter media	Polypropylene	Pleated polypropylene	Pleated polypropylene	Stainless steel fibre or stainless steel mesh 1.4301 (304)	Polypropylene
Retention rates [µm]	0.5; 1; 3; 5; 10; 20 absolute 30; 50; 75; 100; 150; 180 nominal	0.4; 1; 3; 5; 10; 30 nominal	1; 3; 5; 10; 15; 25; 50 nominal	1 nominal; 5; 25; 50; 100; 250 absolute*	1; 3; 5; 10; 20; 50; 75; 100; 150 nominal
Support liner		Polypropylene	Polypropylene	1.4301 (304)	
End caps		Polypropylene	Polypropylene	1.4301 (304)	
O-rings (others on request)	EPDM	EPDM	EPDM	EPDM	EPDM
Element sizes	10"; 20"; 30"; 40"	10"; 20"; 30"; 40"	10"; 20"; 30"; 40"	10"; 20"; 30"	10"; 20"; 30"; 40"
Connections	P7, no end caps	P2, P3, P7, P8, P9, uf, DOE	DOE	P7, uf	P7, no end caps
Recommended housings	PF-EG, P-KG	PF-EG, P-KG	P-KG	PF-EG	PF-EG, P-KG
Conformity	<b>FDA</b> 	<b>FDA</b> 	<b>FDA</b> 	<b>FDA</b> 	<b>FDA</b> 
Operating temperature	Up to +80 °C	Up to +82 °C	Up to +82 °C	Up to +200 °C	Up to +80 °C
Maximum differential pressure	2 bar	5.5 bar (<+35 °C), 2 bar (<+80 °C) in flow direction	5.5 bar (<+35 °C), 2 bar (<+80 °C) in flow direction	10 bar	2 bar
Application examples	Fine filter for liquids	Prefilter for liquids	Prefilter for liquids	Prefilter for liquids	Coarse and prefilter for liquids
Industries	 Food  Beverages  Industrial Machinery  Environment  Chemical	 Food  Beverages  Environment  Pharmaceutical  Chemical	 Food  Beverages  Environment  Chemical	 Food  Beverages  Paints & Coatings  Environment  Pharmaceutical  Chemical	 Food  Beverages  Industrial Machinery  Environment  Chemical

\* Retention rates in water

# Efficient Cleaning

## Liquid Filter Connections

### Connections

Donaldson also supplies elements with different types of adapters that fit into the housings of other manufacturers.



**P2**  
226 O-rings  
bayonet 2 locking tabs  
flat end cap

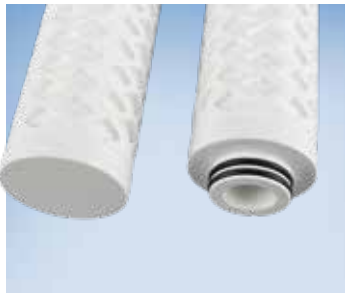

**P3**  
222 O-rings  
plug connection  
flat end cap



**P7**  
226 O-rings  
bayonet 2 locking tabs  
locating fin



**P8**  
222 O-rings  
plug connection  
locating fin



**P9**  
222 O-rings  
bayonet 3 locking tabs  
locating fin

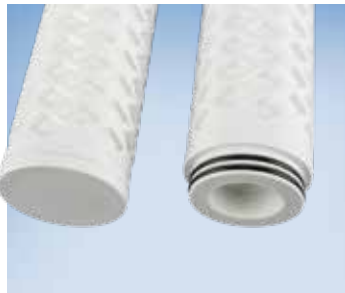

**uf (ultrafilter)**  
226 O-rings  
plug connection  
flat end cap



**DOE**  
Double open end with EPDM gaskets

# Steam Sterilisation Instructions for Liquid Filters

## Work Flow: Sterilisation Instructions for Liquid Filters in Flow Direction

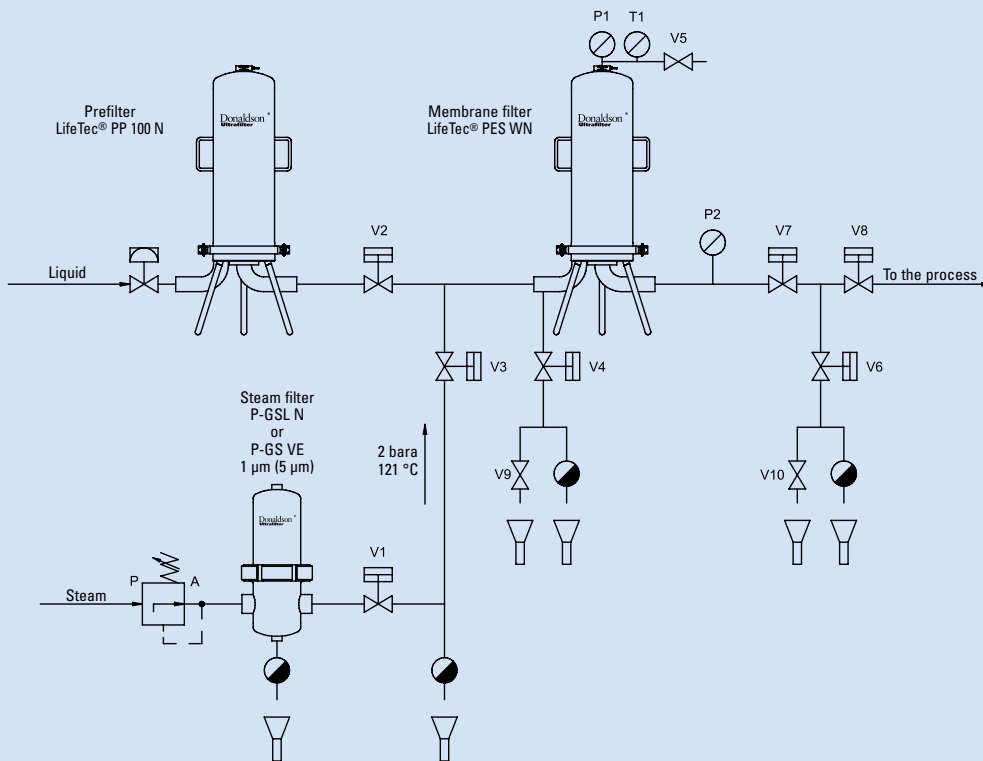

- (1)** Open valves V4, V6, V7, V9 and V10.
- (2)** Drain the product from the filter system and associated piping. Opening valve V5 will aid this process.
- (3)** Open valve V1 and allow the steam condensate to drain until the steam trap below valve V3 closes. Close valve V9.
- (4)** Slowly open V3 allowing steam into the system: this will flow across the filters and through valve V4 and V5. This will allow the heating of the housing, the filters and associated piping without generating a significant differential pressure across the filters.
- (5)** When 'live' steam flows from valve V5 and T1 shows sterilisation temperature, close valve V5. This will direct the steam through the heated filter. Close valve V10.
- (6)** Observe the pressure gauges P1 and P2, control the steam flow rate at valve V3 and set the sterilisation steam pressure to approx. 300 mbar above the required saturated steam pressure (P1).
- (7)** Ensure that the differential pressure between P1 and P2 does not exceed 0.2-0.3 bar g.
- (8)** When the steam trap below valve V6 closes, the steam pressure will begin to rise.
- (9)** Steam sterilise the cartridges for the time specified ensuring the conditions of temperature and pressure stay at a constant level.
- (10)** On completion of the Sterilisation-In-Place cycle, close V4, V6, V3 and V1 in that order.
- (11)** Slowly open V10 to release the steam pressure from the filter system and associated piping. When the pressure on P2 reads 0.1 bar g pressure close valve V10. Fully open valve V9 to release the remaining steam pressure from the filter system. When the pressure on P1 reads 0.1 bar g pressure, close valve V9.

See our sterilisation guide for additional information!

# Integrity Test Devices

## Services by Donaldson

Donaldson offers a wide range of services around the different filter elements and their installation. There are various integrity test devices available, which are characterized by a quick and easy operation and can be purchased.

## Membra-Check for Membrane Filters

The Membra-Check is used for the integrity measurement of membrane filters. In addition,

unknown volumes can be measured or it can be used as a calibration measuring instrument for checking pressure transducers.

## Filter Test Center (FTC) for Depth Filters

The integrity of depth filter elements is checked in the area of critical particle sizes via a test aerosol with the aid of the FTC.



Membra-Check



Filter Test Center (FTC)

**Donaldson**<sup>®</sup>  
**Ultrafilter**

Compressed Air Filtration · Filters for Sterile Air, Steam and Liquids · Refrigerant Drying · Adsorption Drying · Condensate Drains · Condensate Purification Systems · Process Air and Gas Processing



**Donaldson**<sup>®</sup>  
FILTRATION SOLUTIONS

## Total Filtration Management

Donaldson offers a wide variety of solutions to reduce your energy costs, improve your productivity, guarantee production quality and help protect the environment.

## Total Filtration Service

A comprehensive range of services keeps your production at peak performance and at the lowest total cost of ownership.

Please contact us:

Donaldson Filtration Deutschland GmbH  
Büssingstraße 1  
D-42781 Haan · Germany  
Phone: +49(0)21 29 56 90  
[CAP-europe@donaldson.com](mailto:CAP-europe@donaldson.com)  
[www.donaldson.com](http://www.donaldson.com)