

# Hydraulic Filtration

## Capabilities and technical references

Return Line Filters • Suction Line Filters • In-Line Filters • Service Instructions • Accessories



### **Donaldson Delivers Performance Under Any Pressure!**

Clean, dry oil is essential for your equipment.

Donaldson Company, a leader in filtration solutions for 100 years, has proven performance in thousands of applications – offering the industry's largest selection of replacement hydraulic, lube and gear oil filtration products for contamination control.

Distributed by:

# Donaldson introduces new product line

## FLK Medium Pressure Hydraulic Filtration

### Engineered Filtration Power

Donaldson FLK filtration technology delivers all the latest hydraulic filtration advancements for Original Equipment Manufacturers in a single package. The FLK system, a reusable housing with disposable filter cartridge, can be configured with Donaldson's advanced Synteq XP™ media technology – or with other Donaldson media offerings – to satisfy a wide range of performance requirements.

### Optimum Housing Design

FLK assemblies provide high pressure fatigue ratings. This robust, reusable housing and disposable cartridge design creates less waste than standard metal spin-on designs. The versatile FLK filter head also accommodates multiple filter lengths – reducing part numbers stocked while offering greater application coverage.

### Cleaner, Easier Servicing

Industrial, raised hand grips make it easy to remove the housing from the head without the need for special servicing tools. The oil drain port on the bottom of the housing and the locking grab handles on the filter cartridge allow for cleaner servicing. The filter handles lock into place – simplifying positioning during reassembly. Short removal clearance is needed for filter replacement so the assembly can easily fit into tight spaces.

### Our FLK hydraulic filtration systems are packed with innovative features that deliver cleaner, error proof filter servicing.

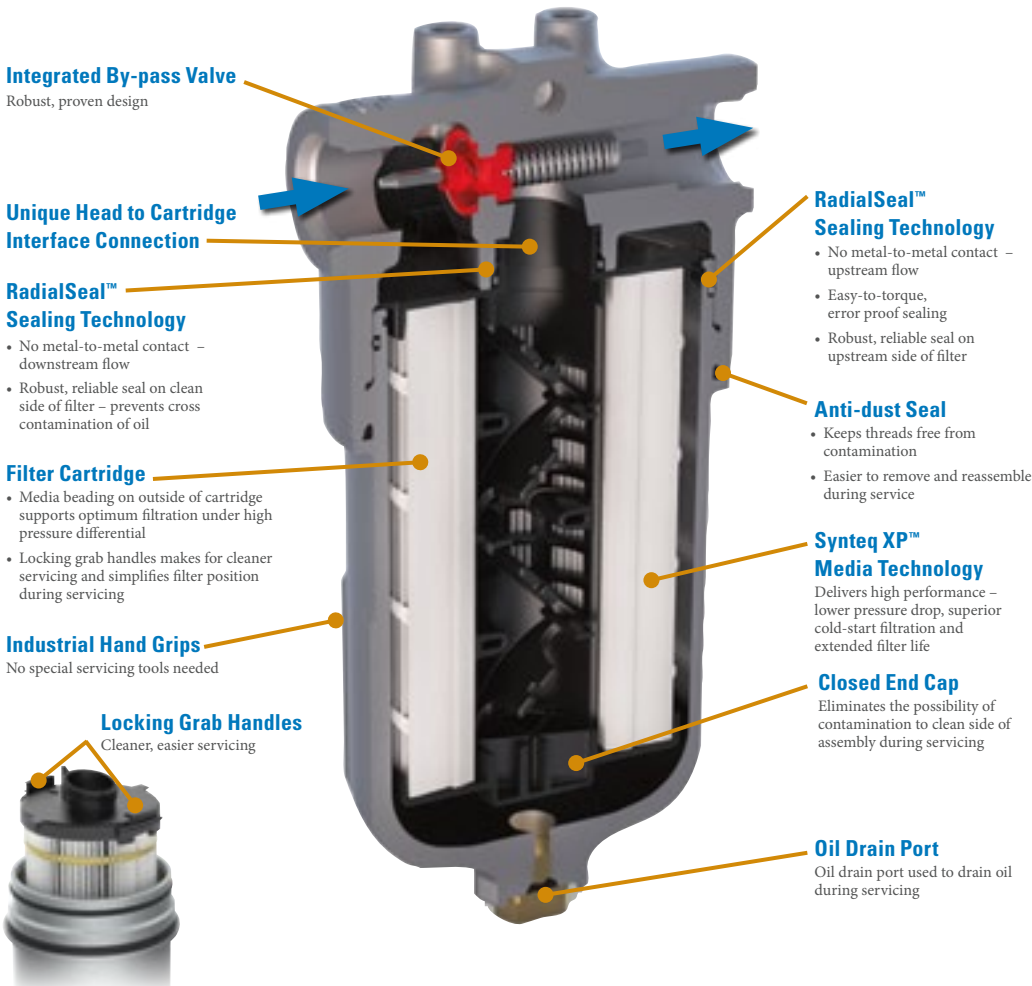

### Environmental Care

Donaldson offers an optional metal-free, high-capacity cartridge that can be easily crushed or fully incinerated.





## Industry Proven Sealing Technology

### Enhanced Reliability

Donaldson pioneered RadialSeal™ sealing technology for air filtration more than 20 years ago. We've applied this proven design to hydraulic filtration in order to create a clean, leak-resistant seal – with no metal-to-metal contact for a new standard in system cleanliness.

This improved sealing technique protects systems from harmful ingressed contaminants and also prevents cross contamination of oil. By moving the threads outward, the RadialSeal interface increases the surface area which provides a robust connection with superior vibration resistance, a common challenge in today's heavy-duty applications.

### RadialSeal™ Guarantees a Reliable, Sure-Fit

Robust seal on the clean side of filter is easy-to-torque and provides error-proof filter servicing. No metal-to-metal contact on both the downstream and upstream sides means no cross contamination of oil.

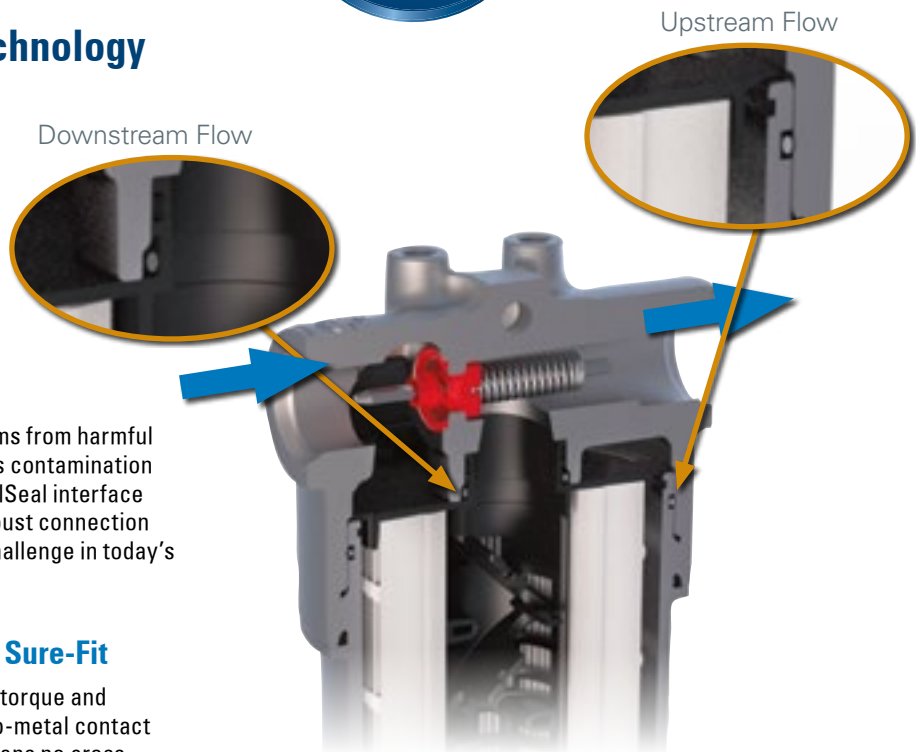

## Industry Shaping Media Technology

### Synteq XP™ Media Technology for Optimal Filtration Performance

Donaldson's breakthrough in synthetic filter media technology takes hydraulic filtration performance to a whole new level. This resin-free bonded media provides improved filtration to increase filter dirt holding capacity and reduce pressure drop, resulting in enhanced system performance and protection.

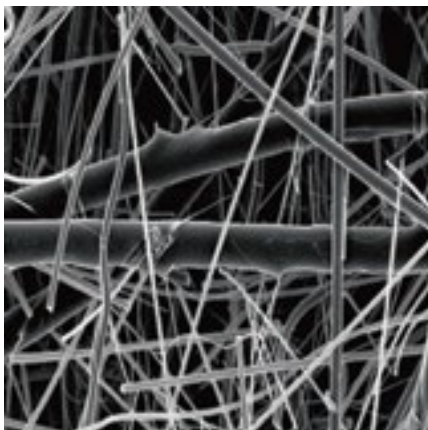

### Synteq XP™ Media

Synteq XP is thermally bonded together to create small, consistent fibers – increasing the filter capacity. The pores remain unobstructed, resulting in reduced pressure drop and more surface area for capturing and retaining smaller particles.

Synteq XP Delivers:

- Lower operating pressure drop
- Higher efficiency for optimal hydraulic system protection
- Superior cold-start filtration
- Extended filter life (up to 2 to 3 times that of traditional media)

## Hydraulic filtration solutions Engineered for today's industrial & mobile equipment



### The best solutions for clean, dry oil.

Count on Donaldson to have the right filters, contamination control products and services to protect critical components in hundreds of applications – in the factory and on heavy-duty mobile equipment.

**When you need hydraulic filtration, Donaldson delivers.**

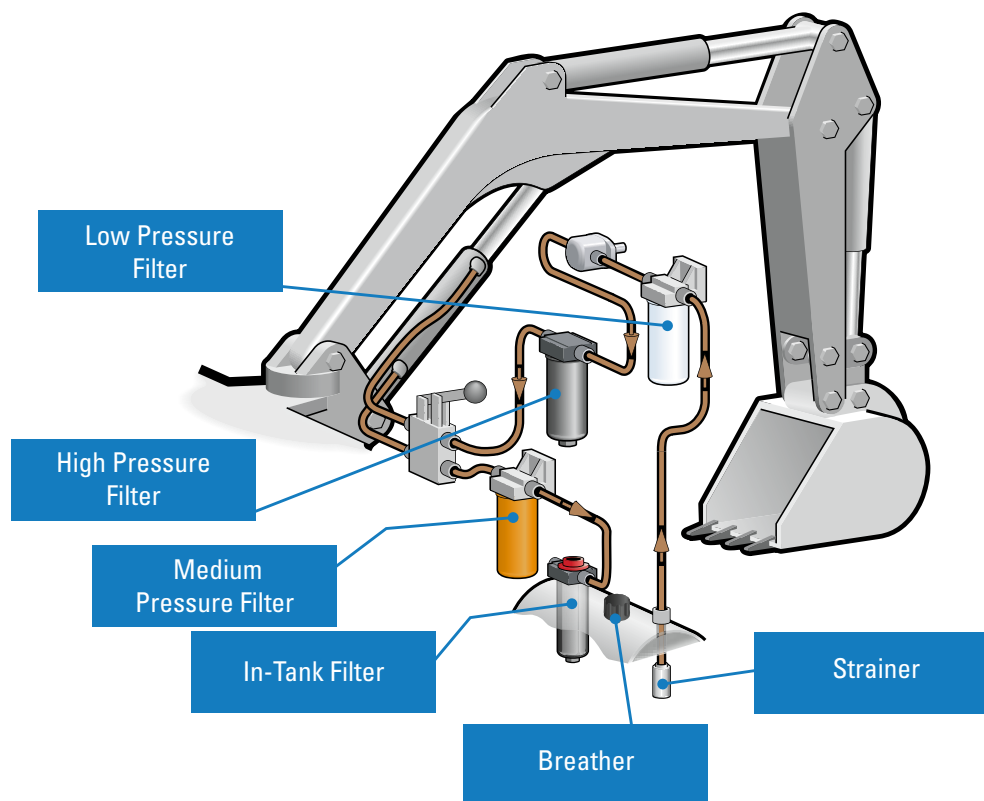

### Full product range

The industry's largest selection of in-stock filters and accessories – manufactured with consistent, high-quality performance.

### Expert technical support

Prompt, accessible and knowledgeable customer service experts.

### High-performance filtration

Increase dirt-holding capacity and lower  $\Delta P$  with Donaldson high-performance DT filters.

## Hydraulic filtration solutions Engineered for today's industrial & mobile equipment



### Performance under any pressure

- Low, medium and high pressure filtration
- Spin-on, cartridge and in-tank style filters

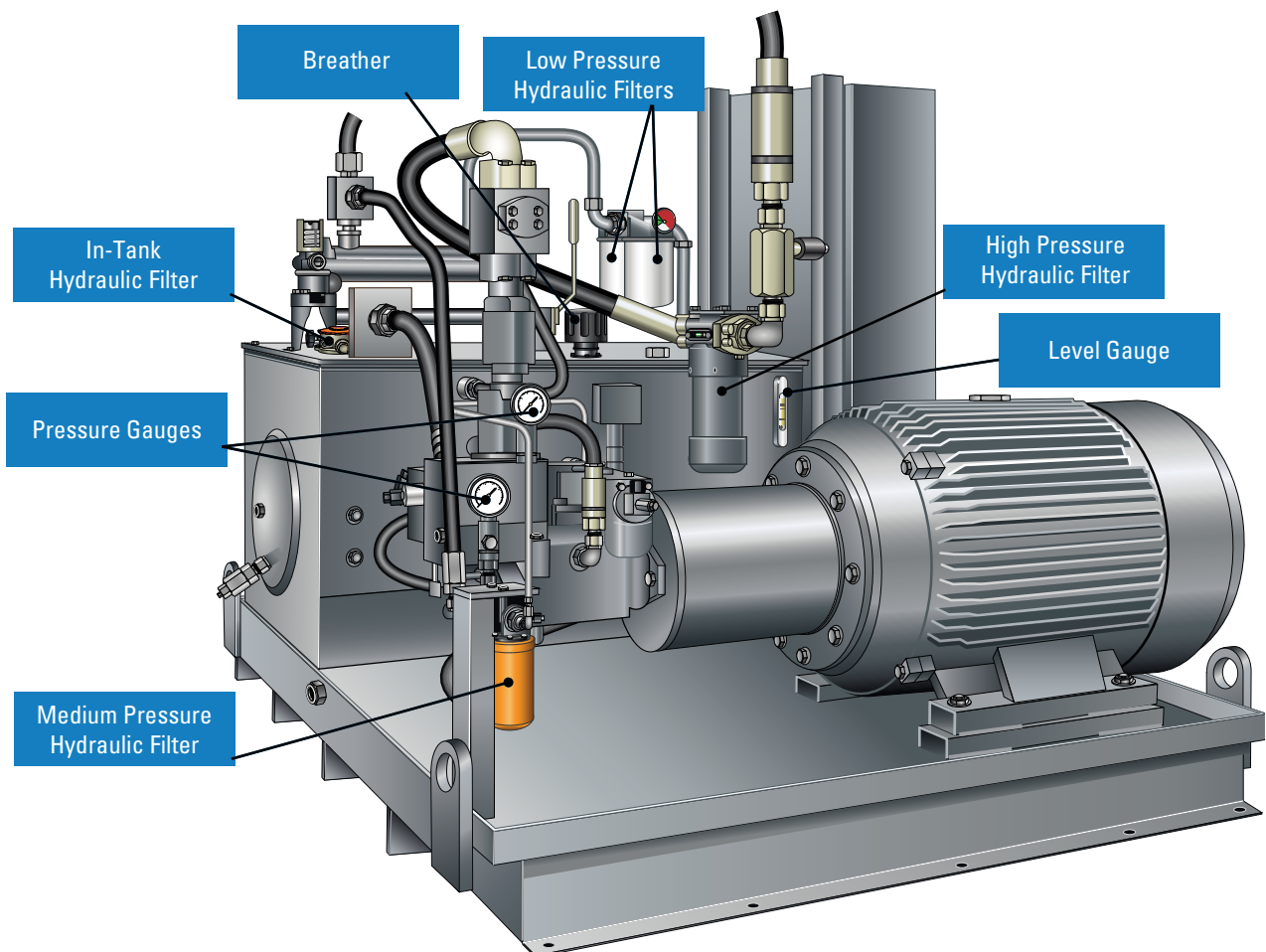

#### Off-line filtration

Filter carts, filter panels and Filter Buddy™ handheld filtration.

See Catalog No. F112100 ENG

#### Water removal

Systems and products designed to prevent water ingress and remove entrained water.

#### Vacuum dehydrators & coalescers

Quick removal of free water, dissolved water, particles and gases.

## Industry shaping technology Global design & logistic capabilities



Donaldson has pioneered the use of a wide range of engineering, design and testing tools used during the product development and validation process.

### Engineering capabilities

- Design centers in three key regions – Europe, United States and Asia

#### Prediction and simulation

- CAD
- Media modeling
- Fluid mechanics
- Structural analysis
- Thermal analysis

### Development and validation

#### Filter durability

- Filtration performance testing per applicable SAE and ISO standards
- Fabrication integrity
- Environmental conditions
- Salt spray and thermal cycling
- Pressure fatigue
- Flow fatigue
- Hydrostatic burst
- Flow benches
- Vibration benches
- Gravimetric analysis

#### Rapid prototyping

- SLA, SLS
- Investment casting
- RTV molding

### Test & evaluation tools

#### Structural Analysis

- Per SAE, ISO, and NFPA standards
- Burst
- Collapse
- Pressure impulse and fatigue

#### Tensile compression

- Used to test material, component and assembly properties

#### Environmental chambers

- Allows testing at hot or cold temperature, with humidity control

#### Flow test benches

- Allows measurement of static and dynamic flow and restriction for a device
- Allows calculation of device restriction at varying flows and temperatures
- System simulation

#### Filtration performance testing

- ISO, SAE, NFPA
- Customer standards
- Contaminant (particle or water) removal efficiency
- Contaminant capacity

#### Analytical chemistry laboratory

- Optical microscopy
- Scanning electron microscopy (SEM)
- Chemical analysis
- Fourier transform infrared (FTIR)
- Gas chromatography (GC/MS)
- Thermal analysis (DSC, TGA)
- Liquid chromatography

## Industry shaping technology Global design & logistic capabilities

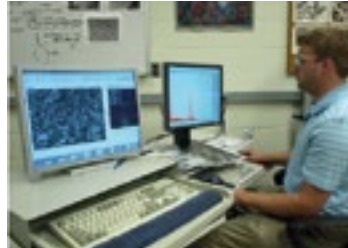

### Design validation

- Test cell locations in three key regions – United States, Asia and Europe
- High viscosity  $\Delta P$
- High temperature
- Flow fatigue
- Used oil analysis
- Component durability
- 24/7 durability testing
- Web-based test cell monitoring access
- Fluid compatibility

### Vibration/shaker

- Multiple benches
- Performance vibration with flow test
- Can apply random, shock or custom variable vibration profiles
- Capable of hot or cold tests

### Field testing

- On and off highway
- Heavy-duty
- Tests conducted on both end user and OEM applications

### Field data acquisition

- Real time measurements
- Remote communications
- On-line collection tools
- Review daily, weekly and monthly reports to analyze operational trends

### Quality certified

- All facilities are ISO/TS certified

### Quality controls

- Consistent, reliable product
- On-site verification test units and equipment
- Part number specific PLC controls
- Manufacturing dates for tracking and warranty

### Manufacturing

#### Locations for liquid filtration

- Europe, United States, Canada, Mexico and Asia-Pacific
- Located strategically with global partners

#### Base component materials

- Built for long-life, durability, corrosion resistance and liquid compatibility
- Metal and non-metal materials
- Methods to enhance media durability include oven-curing, wire backing and multiple layered media

#### Packaging options

- Returnable packaging
- Heavy-duty packaging
- Pallets ISPM-15 compliant for international routing

### Logistics / distribution

Donaldson has established a global distribution network to serve our customers locally and around the world. We operate as a global company with a network of primary distribution locations that support a mature hub of regional distribution centers and warehouses.

Donaldson distribution centers are strategically located around the globe to quickly and accurately deliver filtration and exhaust products wherever replacement products are needed. We work with a network of transportation, third party logistics companies, consolidators and cross-docking facilities to meet or exceed our customers' requirements.

Customers around the world benefit from our umbrella of distribution centers. We focus our efforts on local support and the capabilities of our staff. We continue to make significant investments in facilities, systems, supply chain relationships and staffing to offer the best order fulfillment options available.

## Industry shaping technology Donaldson Italy capabilities

### Leader in designing and manufacturing liquid filters

Donaldson Italia Srl was established in 1992, when DCI bought the existing Italian filter manufacturing company FBO, specialized in hydraulic filtration (industrial & mobile).

The company grew during the last 20 years, passing from 50 up to 210 employees. Over the years, Donaldson Italia Srl was and is able to develop new synthetic media, spin-ons and high pressure filters. This mainly thanks to the synergy with DCI and by supplying a huge number of OEM's. One of our main characteristics is the big flexibility and the capacity to develop customized products.

As all Donaldson factories, Donaldson Italia srl achieved the quality certification according to ISO 9001/2 and ISO 14000 as well as quality certification of our major OEM customers.



Donaldson Italia Srl in Ostiglia, Mantova (Italy)

### Donaldson Italy Srl manufacturing means quality production

Most of the filter production process is automated, this enables us to build filters faster and with higher precision.

Daily plant production capacity (10.000m<sup>2</sup>):

- 4.000-8.000 Duramax hydraulic spin-ons
- 3.000-5.000 hydraulic cartridges
- 1.000 hydraulic filter assemblies
- 4.000 low pressure spin-on filters and liquid filters.

Recent investments in a new liquid lab and the engineering and sales office doubled the production facility.





## Industry shaping technology Mix&Match – your flexible hydraulic solutions

### History

**Mix&Match is introduced to provide you more flexibility and a higher availability of hydraulic products.**

You can create your own complete filter by selecting separately a housing, a cartridge and an indicator. The majority of these components will be stocked to provide you fast with the products you need.

### The idea of Mix&Match

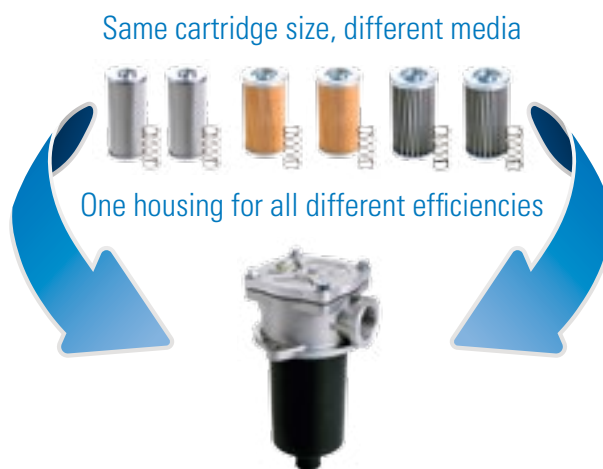

### How to create your hydraulic product via the catalog?

The tables are composed in such a way that all components that fit together are on 1 row.

1. Pick the product series depending from the position in the hydraulic system, the working pressure and the required flow
2. Pick the required element based upon flow and efficiency
3. Follow this row to the right and the available (empty) housing is shown
4. Pick the indicator of your choice (make sure that it fits the predrilled hole).

Family	B		A		D		Standard Housing without Cartridge	CARTRIDGE DIMENSIONS			POSSIBLE INDICATOR				
	RMF	90µm	RMF	50µm	RMF	5-21000		A	B	C		D	X	Y	Z
FI020	20	P171500	20	P171505	15	P171504	P766486	G3/8	67	78	132	67	52	25.5	P171903 P171958 P171906 P173104
FI030	30	P171500	30	P171505	20	P171504	P766447	G1/2	67	78	132	67	52	25.5	
FI050	50	P171518	50	P171523	25	P171522	P766488	G1/2	90	100	172	75	70	29	

All cartridges are delivered with a sticker, with the Donaldson cartridge spare part number, that will mark the housing from the outside. All complete Mix&Match filters need to have this sticker attached to the outer housing.

## Hydraulic Filter Locations Comprehensive Selection of Filtration Solutions

### Typical Hydraulic Circuit and Filter Locations



Filter Symbol in a Circuit



**Pressure Line Filter**

Protects high-pressure side components. Helps prevent component wear or failure brought about by debris in the system.



**In-Line Accessories**

Pressure gauges for monitoring system pressure. Hoses and test points for sampling oil and determining ISO cleanliness levels. Flanges and valves for system control.



**Suction Line Filter**

Designed to remove particles in the 5 to 150 micron range. Easy to service and less expensive than other types of filters. Low by-pass valve use recommended to prevent pump starvation.



**Reservoir Air Breather**

Prevents ingress of airborne contaminants from entering the reservoir tank.



**Suction Strainer**

Removes large particles or objects built into the system during assembly or introduced during standard maintenance. Prevents catastrophic failure.

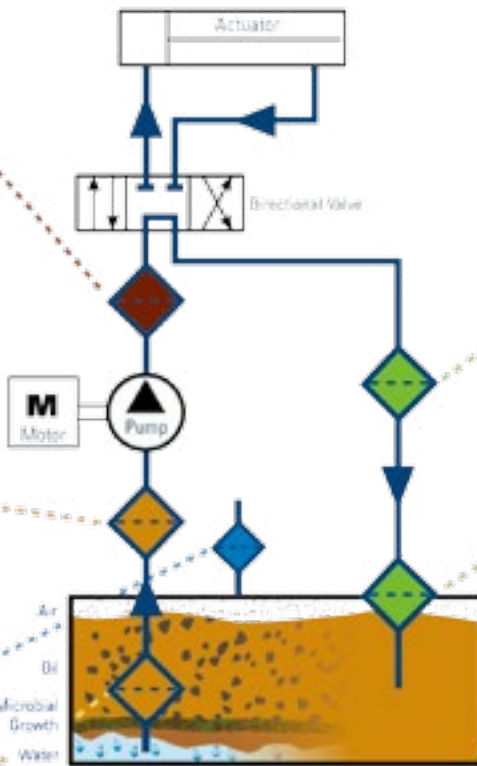

**Reservoir Tank**

Water in reservoir tanks is a serious threat to hydraulic systems. Dirt, particles and microbial growth are also common contaminants existing in tanks.



**Return Line Filter**

Captures debris from component wear or ingestion before it travels into the reservoir.



**In-tank Return Line Filter**

Space-saving in-tank return and suction line filters.



**Reservoir Accessories**

Sight and level gauges available. Diffusers are used for effectively reducing aeration/foaming, turbulence and noise caused by return lines.



**Kidney Loop Filters**

Off-line filtration supplements system cleanliness. Use with industrial and mobile equipment to achieve and maintain proper ISO cleanliness levels.

Donaldson provides this technical reference as a short course in “Hydraulic Filtration” – for those who want to gain a better understanding of hydraulic filtration.

In industrial and mobile applications at factories all over the world, we too often see hydraulic circuits that don’t include proper fluid filtration, or include it as an afterthought. Good filtration needs to be an integral part of the hydraulic circuit to ensure the long life and proper operation of the pumps, valves and motors.

**A €100 filter protects your €100,000 equipment.**

This section is offered to aid in choosing the filter that will help you achieve the ideal cleanliness levels and longest life for your critical components.

### Topics

Hydraulic Components Need Protection	14
How Contamination Damages Precision Parts	14
Types of Contaminant	14
Typical Factors in Component Life	14
Where Contamination Comes From	15
Fluid Conditioning	16
Proper Filter Application	17
Fluid Properties	17
Types of Hydraulic Fluid	18
How Filter Media Functions in a Filtration System	19
How Filter Media Collects Particles	19
Basic Types of Hydraulic Filter Media	20
Donaldson Filter Media Efficiency Ratings per ISO 16889 Test Standards	22
Hydraulic Filtration Pressure Drop	23
Four Major Factors Contribute to Pressure Drop	23
Viscosity/Temperature Chart	24
Filter Design and Construction	25
Combining the ISO Rating and Filter Performance Ratings	26
Filter Efficiency Standards	28
Donaldson Hydraulic Filter Media Beta Ratings	30
Cleanliness Level Correlation Table	31
Compatibility of Donaldson Filter Media with Hydraulic Fluids	32
Threads	32

### Symbols Used

$\beta$	Beta Ratio
cSt	Centistokes
DP	Pressure Drop or Differential Pressure
ISO	International Standards Organization
$\mu\text{m}$	Micron or micrometer
ppm	Parts per million
SSU	Saybolt Seconds Universal

Material in this section is in the public domain, not confidential, and may be copied for educational purposes at any time. Information was collected from many sources, both public and private, including Donaldson Company, Inc. Engineering Departments, Eaton Corporation, the Lightning® Reference Handbook from Berendsen Fluid Power, Hydraulics & Pneumatics Magazine, National Fluid Power Association (NFPA), and various industry authorities.

## Hydraulic Components Need Protection

Fluid power circuits are designed in all shapes and sizes, both simple and complex in design, and they all need protection from damaging contamination. Abrasive particles enter the system and, if unfiltered, damage sensitive components like pumps, valves and motors. It is the job of the hydraulic filter to remove these particles from the oil flow to help prevent premature component wear and system failure. As the sophistication of hydraulic systems increases, the need for reliable filtration protection becomes ever more critical.

## How Contamination Damages Precision Parts

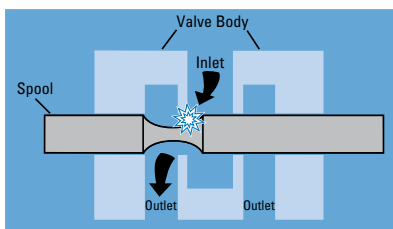

This illustration of a simple hydraulic valve illustrates how particles damage components. In normal operation,

the spool slides back and forth in the valve body, diverting oil to one side of the valve or the other. If a particle lodges between the spool and valve body, it will erode small wear particles from the metal surfaces. As these wear particles are moved back and forth by the action of the spool, they can roll into a burr that jams the spool and disables the valve.



### Component Damage

Looking down the barrel of an hydraulic cylinder, we can see the scratches along the inside surface. Don't cut costs by eliminating hydraulic filters. It could cost you more in the long run in major component repairs.

## Types of Contaminant

- Many different types of contamination may be present in hydraulic fluid, causing various problems. Some are:
- Particulate (dust, dirt, sand, rust, fibers, elastomers, paint chips)
- Wear metals, silicon, and excessive additives (aluminum, chromium copper, iron, lead, tin, silicon, sodium, zinc, barium, phosphorous)
- Water
- Sealants (Teflon®\* tape, pastes)
- Sludge, oxidation, and other corrosion products
- Acids and other chemicals
- Biological, microbes (in high water based fluids)

\* Teflon is a registered trademark of E.I. DuPont de Nemours & Co., Inc.

## Typical Factors in Component Life

Studies show that most (typically 70%) of hydraulic component replacement is necessary because of surface degradation, and most of that is due to mechanical wear. Proper filtration of hydraulic fluids can lengthen component life.

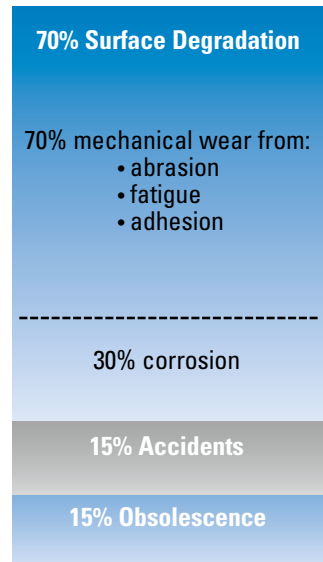

### Disaster Strikes

When filters are not a main component of the hydraulic circuit, disaster awaits. Here, piston rings were eaten away by contaminants.

## Where Contamination Comes From

There are a surprising number of contaminated sources in a hydraulic system or circuit.

### New Hydraulic Fluid

Adding new fluid can be a source; even though it's fresh from the drum, new hydraulic fluid isn't clean. (It may look clean, but, remember, the human eye can only see a particle the size of about 40 µm.) Oil out of shipping containers is usually contaminated to a level above what is acceptable for most hydraulic systems: typically, new fluid has a cleanliness level about the same as ISO Code 23/21/19, and water content is typically 200 to 300 ppm. Never assume your oil is clean until it has been filtered. One very effective way of ensuring thorough fluid conditioning is with a dedicated off-line circulation loop, or "kidney" loop filtration.

### Built-In

Built-in contamination, also called primary contamination, is caused during the manufacture, assembly and testing of hydraulic components. Metal filings, small burrs, pieces of Teflon tape, sand and other contaminants are routinely found in initial clean up filtration of newly manufactured systems.

### Ingressed

Ingressed or external contamination comes from the environment surrounding the system. Dirt can enter the hydraulic fluid supply through leaking seals, reservoir breather caps, and worn cylinder rod seals. Ingressed moisture, particularly, can cause long-term problems. As a hot system cools at night, cool moisture-laden air can be drawn into the reservoir; as the air condenses, water is released into the reservoir. Water in excess of 0.5% by volume in a hydrocarbon-based fluid accelerates the formation of acids, sludge and oxidation that can attack internal components, cause rust, and adversely affect lubrication properties. The severity of ingress and type of contaminant are dictated by the applications and environment.

### Induced

Maintenance procedures can introduce contamination into the system. Opening the system allows airborne particles to enter. Leaving the system open during operation provides continuous ambient particle ingress. Keep your system closed as much as possible.

## In-Operation

The major source of contamination are the pump and actuators, the hydraulic cylinder, or the hydraulic motor. Wear-generated contaminants are a hazard during normal hydraulic system operation. The circuit actually generates additional particles as the fluid comes into contact with the precision machined surfaces of valves, motors and pumps. Contaminant levels can keep doubling with every new particle generated. The result can be catastrophic if these contaminants are not properly filtered out of the system.

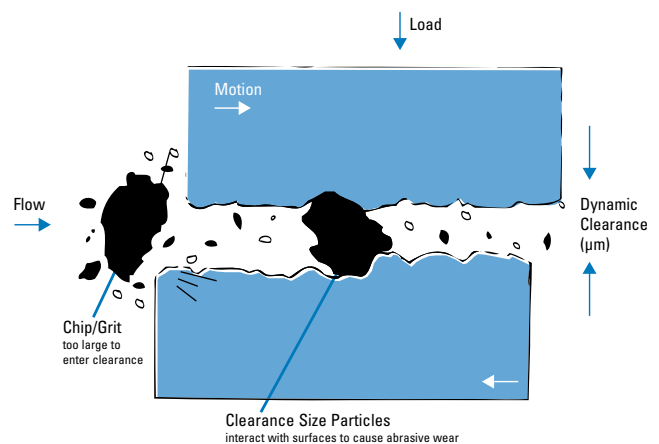

## Rubber & Elastomers

Due to temperature, time, and high-velocity fluid streams, rubber compounds and elastomers degrade – thus releasing particulates into the fluid. This may be from hoses, accumulator bladders, seals, or other elastomer products.

## High Water Based Fluids

The water in HWBF tends to support biological growth and generate organic contamination and microbes.

## Replacement of Failed Components

Failure to thoroughly clean fluid conductor lines after replacing a failed hydraulic pump will cause premature catastrophic failure.

Donaldson recommends frequent oil sampling to ensure proper contamination control. Sample test points should be close to hydraulic pumps and at other key locations that provide safe, reliable access to the fluid while under full system pressure.

## Fluid Conditioning

Fluid Conditioning is the term for the overall conditioning of the fluid in the hydraulic system, and encompasses particulate removal via filters along with other various methods for removing silt, air, water, heat, acid, sludge or chemicals.

### Particulate Removal

Particulate removal is usually done with mechanical filters. A well designed reservoir that allows settling will also help in keeping particulates out of the mainstream fluid. For ferrous particulates and rust, reservoir magnets or strainer band magnets can also be used. Other methods such as centrifuging or electrostatic filtration units can also be used, particularly in continuous batch processing and fluid reclamation.

### Removal of Silt

Silt, defined as very fine particulate under 5 µm in size, requires very fine filtration or “oil polishing.”

### Air Removal

Getting air out of the system is best done by adding 100 mesh screen in the reservoir, approximately 30° from horizontal to coalesce entrained air and allow larger bubbles to rise to the surface when reservoir velocities are low.

### Water Removal

A number of techniques exist to prevent water or moisture ingress or to remove water once it is present in a hydraulic or lube oil system. The best choice of technique for removal is dependent on the whether or not the water exists as a separate phase (dissolved or free), and also on the quantity of water present. For example, the presence of water or moisture can be reduced or prevented from entering a fluid reservoir through the use of absorptive breathers or active venting systems. However once free water is present in small quantities, water absorbing

filters or active venting systems usually provide adequate removal means. For large quantities of water, vacuum dehydration, coalescence, and centrifuges are appropriate techniques for its removal. However, as each of these techniques operates on different principles, they have various levels of water removal effectiveness. The chart below provides comparative information on these techniques and their relative effectiveness. Care should be taken to apply the best technique to a given situation and its demands for water removal.

### Chemical Removal

Removal of acids, sludge, gums, varnishes, soaps, oxidation products and other chemicals generally requires an adsorbent (active) filter with Fuller Earth, active type clays, charcoal, or activated alumina.

### Heat Removal

Removing heat is important to maintain viscosity and prevent fluid breakdown. Usually performed with heat exchangers, including air-to-oil and water-to-oil types, finned coolers, or refrigerated units.

### Heat Addition

Added heat is used for cold temp start-up to get fluid viscosities within operational limits. Use heaters, immersion or in-line.

### Kidney Loop Filtration

One very effective way of ensuring thorough fluid conditioning is with a dedicated off-line circulation loop, or “kidney” loop. This system uses a separate circulation pump that runs continuously, circulating and conditioning the fluid. Multiple stages and types of filters can be included in the circuit, as well as heat exchangers and in-line immersion heaters.

## Water Prevention and Removal Techniques

	Usage	Prevents Humidity Ingression	Removes Dissolved Water	Removes Free Water	Removes Large Quantities of Free Water	Limit of Water Removal
Adsorptive Passive Breather	prevention	Y				n/a
Active Venting System	prevention and removal	Y	Y	Y		down to <10% saturation
Water Absorbing Cartridge Filter	removal			Y		only to 100% saturation
Centrifuge	removal			Y	Y	only to 100% saturation
Coalescer	removal			Y	Y	only to 100% saturation
Vacuum Dehydrator	removal		Y	Y	Y	down to ~20% saturation

## Proper Filter Application

When selecting a new filter assembly or replacement filter, it's important to first answer some basic questions about your application. Where will the filter be used? What is the required cleanliness level (ISO code) of your system? What type of oil are you filtering? Are there specific problems that needed to be addressed?

It's also important to think about the viscosity of the fluid in your system. In some machinery lubrication applications, for example, the oil is very thick and has a tougher time passing through the layer of media fibers. Heating techniques and the addition of polymers can make the liquid less viscous and therefore easier to filter. Another option is to install a filter with larger media surface area, such as the Donaldson W041 or HRK10 low pressure filters, that can accommodate more viscous fluids. (see Catalog No. F112100)

Next, think about duty cycle and flow issues. Working components such as cylinders often create wide variations in flow – also called pulsating flow – that can be problematic for filters with higher efficiency ratings. On the other hand, dedicated off-line filtration (also called “kidney loop”) produces a very consistent flow, so it makes sense to use a more efficient filter.

Filters used in applications with steady, continuous operation at lower pressures will last longer than filters that must endure cycles of high pressure pulsating flow. Generally, the lower the micron rating of a filter, the more often it needs to be changed since it is trapping more particles.

Finally, it's wise to ask yourself, “How much is my equipment worth?” Calculate how much it would cost to replace the equipment in your system, in case of component failure, and make sure those areas are well protected with proper filtration. (For example, high performance servo valves are very sensitive, costly components that need to be protected with finer filtration media.)

Minimizing maintenance costs through good contamination control practices requires proper filter application based on the specific contamination problems. Good contamination control means cost-effective filtration. When looking for a filter, first assess the needs of your system and any problem areas.

## Characteristics to Consider When Specifying a Filtration System

1. Oil Viscosity
2. Flow
3. Pressure
4. What Components will be protected by the filter
5. Cleanliness level required (expressed in ISO code)
6. Type of oil/fluid
7. Environment (the system, the surrounding conditions, etc.)
8. Duty cycle
9. Operating Temperature

## Fluid Properties

**Lubricity** The property of the fluid that keeps friction low and maintains an adequate film between moving parts.

**Viscosity** The thickness of the fluid as measured by resistance to flow. The fluid must be thin enough to flow freely, heavy enough to prevent wear and leakage. Hydraulic fluids thicken when they cool and thin out as they heat up. Because some hydraulic systems work under wide temperature extremes, viscosity can be an important factor.

**Viscosity Index (VI)** The rate of viscosity change with temperature: the higher the index, the more stable the viscosity as temperature varies. VI can sometimes be improved by additives, usually polymers.

**Rust Resistance** Rust inhibiting chemicals in hydraulic fluids help overcome the effects of moisture from condensation.

**Oxidation Resistance** Oxidation inhibitors delay the sludgy/acidic effects of air, heat, and contamination in the system.

**Foaming Resistance** Although control of foaming depends largely on reservoir design, anti-foaming additives in the fluid also help.

## Types of Hydraulic Fluid

There are many kinds of fluids used for power, but they can basically be called petroleum-based fluids, biodegradable fluids, and fire-resistant fluids. A brief description of some of the types in each category are listed below; for details on these or others, consult your filter supplier or refer to a reputable manual on hydraulics, such as the Lightning Reference Handbook, published by Berendsen Fluid Power, Whittier, CA 90601.

### Petroleum Based (Hydrocarbon)

These are the most commonly used fluids in hydraulic systems. Their major advantages are low cost, good lubricity, relatively low/non-toxicity, and common availability. This type of fluid is not just plain oil; rather, it is a special formulation with additives that make it suitable for hydraulic systems. Mostly, the additives inhibit or prevent rust, oxidation, foam and wear.

#### Variations:

- Straight oils: same as petroleum-based oil but without the additives.
- Automatic transmission fluids (ATF): excellent low temp viscosity and very high VI.
- Military hydraulic fluids (ie: MIL-H-5606 and MIL-H-83282): also called 'red oil' because of the color. Low viscosity, good for cold temp operations, but may have to be modified for pumps.

### Fire Resistant Fluids

There are two types of fire-resistant fluids commonly used in hydraulic applications: Phosphate Esters and High Water Based Fluids (HWBF). Although generally not as viscous at cold temperatures as petroleum-based fluids, they are fire resistant due to their high content of noncombustible material. Very useful in overcoming the likelihood of fire caused by a broken hydraulic line spraying petroleum fluid into a pit of molten metal, onto a hot manifold, into a heat-treating furnace, or other ignition source.

#### Some types of HWBF:

- Oil-in-water emulsions (HFA): typically 95% water and 5% oil, with the oil droplets dispersed throughout the water. Provide some fire resistance, but due to oil content, other fluids are superior.
- Water-in-oil emulsions (invert emulsion HFB): typically 40% water and 60% oil, with the water dispersed in the oil. Provide some fire resistance, but due to oil content, other fluids are superior.
- Water-glycol (HFC): typically 40% water and 60% glycol. Excellent fire resistance. Since glycol is an antifreeze, water-glycol can be used at lower temps.

NOTE: HWBF may require reduced pressure rating of pumps and other components.

## HFD Fluids

The HFD group is a classification given to several different types of synthetic products that do not contain petroleum oil or water. Phosphate ester fluids were the first HFD fluids and are the most fire resistant within the HFD family. Not as popular today, their use declined due to poor environmental performance, limited compatibility, and high cost.

Certain phosphate esters have very high auto-ignition temperatures and are still used in specific applications, such as aircraft and power generation.

A common brand is known as Skydrol® (registered trademark of Solution, Inc.). Skydrol requires EPR seal for chemical compatibility. Today most phosphate esters have been replaced by polyol esters. Based on organic esters, polyol esters are the most common HFD fluids used today. They offer good inherent fire resistance, good compatibility with system materials, excellent hydraulic fluid performance, and easy conversion from petroleum oil. In addition, the organic nature of these fluids gives them good environmental performance in biodegradability and aquatic toxicity. Another type of synthetic, fire resistant fluids have been formulated for certain niche markets.

Water free polyalkylene glycols (PAGs) feature extended fluid life and good environmental performance. Technically an HFD fluid, PAGs (also known as polyalphaolefins (PAOs)) are more often used for their biodegradability and overall environmental friendliness. This group also contains the synthetic silicone (siloxane) oils, known for their anti-foaming properties.

## Biodegradable

With increasing concern about the environmental impact of hydraulic system leaks and spills, biodegradable fluids are receiving expanded usage, particularly in Europe. There are two types of common biodegradable hydraulic fluids:

1) vegetable-based oils, such as sunflower or rapeseed oils, and 2) synthetic oils like diesters, etc. Generally, systems using biodegradable fluids are derated for maximum and minimum temperatures. Users who replace standard hydraulic oils with biodegradable oils must check with filtration component manufacturers to confirm that the fluid and components are compatible.



## How Filter Media Functions in a Filtration System

The job of the media is to capture particles and allow the fluid to flow through. For fluid to pass through, the media must have holes or channels to direct the fluid flow and allow it to pass. That's why filter media is a porous mat of fibers that alters the fluid flow stream by causing fluid to twist, turn and accelerate during passage.

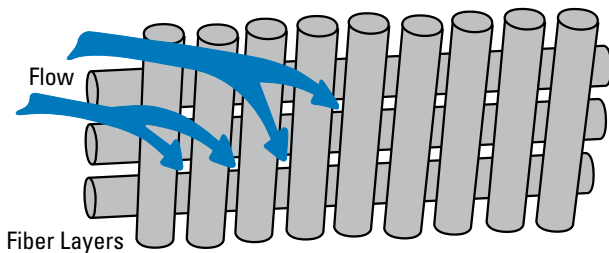

The fluid changes direction as it comes into contact with the media fibers, as illustrated above. As the fluid flows through the media, it changes direction continuously as it works its way through the maze of media fibers. As it works its way through the depths of the layers of fibers, the fluid becomes cleaner and cleaner. Generally, the thicker the media, the greater the dirt-holding capacity it has.

Looking at a cross-section view of the fibers, we can see how the flowstream is accelerated as it flows into the spaces between the fibers.

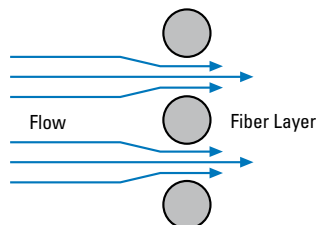

## How Filter Media Collects Particles

There are four basic ways media captures particles

The first, called **inertia**, works on large, heavy particles suspended in the flow stream. These particles are heavier than the fluid surrounding them. As the fluid changes direction to enter the fiber space, the particle continues in a straight line and collides with the media fibers where it is trapped and held.

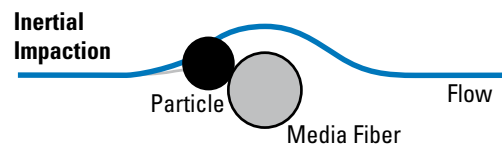

The second way media can capture particles is by **diffusion**. Diffusion works on the smallest particles. Small particles are not held in place by the viscous fluid and diffuse within the flow stream. As the particles traverse the flow stream, they collide with the fiber and are collected.

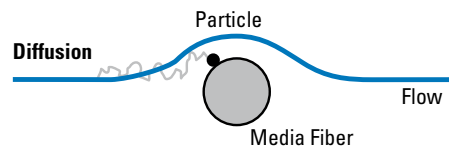

The third method of particle entrapment is called **interception**. Direct interception works on particles in the mid-range size that are not quite large enough to have inertia and not small enough to diffuse within the flow stream. These mid-sized particles follow the flow stream as it bends through the fiber spaces. Particles are

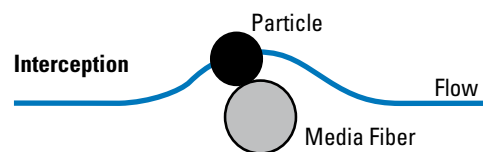

intercepted or captured when they touch a fiber.

The fourth method of capture is called **sieving** and is the most common mechanism in hydraulic filtration. As shown at right, this is when the particle is too large to fit between the fiber spaces.

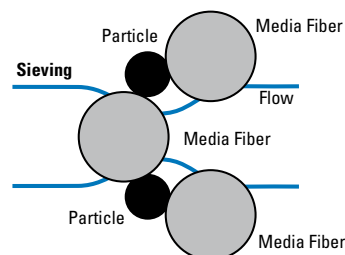

## Basic Types of Hydraulic Filter Media

### Filter Media

Media is a term used to describe any material used to filter particles out of a fluid flow stream. There are four basic types used to remove contamination in hydraulic applications:

#### Cellulose Media (Traditional)

Cellulose fibers are actually wood fibers, microscopic in size and held together by resin. Fibers are irregular in both shape and size. Cellulose often has lower beta ratings, which means there are smaller pores in the media. Smaller media pores cause more flow resistance, resulting in higher pressure drop.

While cellulose provides effective filtration for a wide variety of petroleum-base fluids, in certain applications it results in poor filtration performance as compared to synthetic media.

SEM 100X

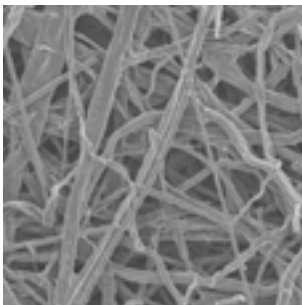

SEM 600X

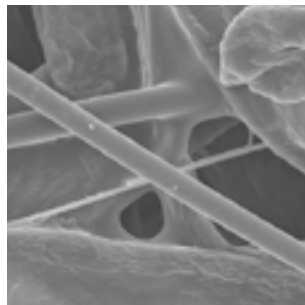

MEDIA IMAGE

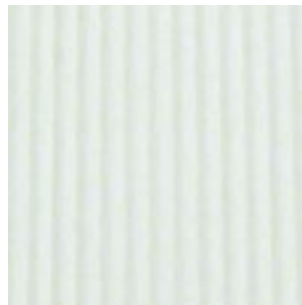

#### HOW IT WORKS

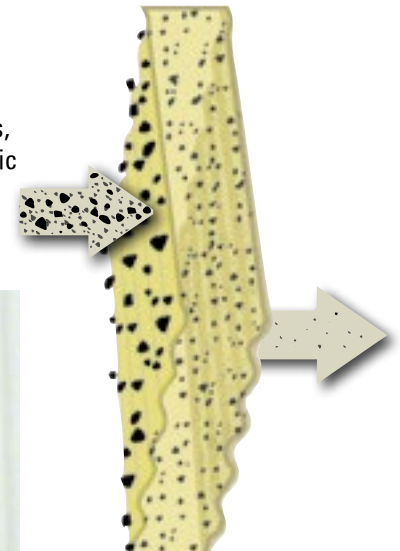

#### Synteq™ Media (Full Synthetic)

Synthetic fibers are man-made, smooth, rounded and provide the least resistance to flow. Their consistent shape allows for control of the fiber size and distribution pattern throughout the media mat to create the smoothest, least inhibited fluid flow. Consistency of fiber shape allows the maximum amount of contaminant-catching surface area and specific pore size control. The result is media with predictable filtration efficiencies removing specified contaminants and maximum dirt holding capacity.

The low resistance of synthetic media to fluid flow makes it ideal for use with synthetic fluids, water glycols, water/oil emulsions, HWCF and petroleum-based fluids.



SEM 100X

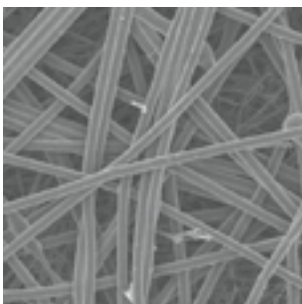

SEM 600X

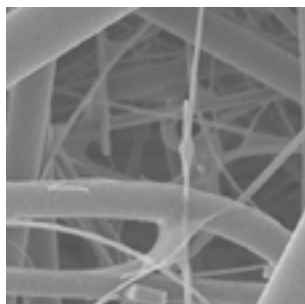

MEDIA IMAGE



#### HOW IT WORKS

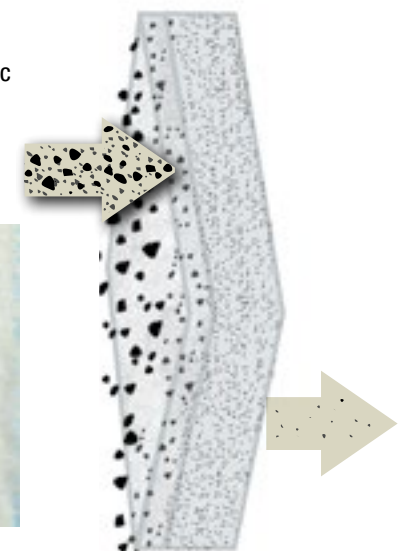

## Wire-Mesh Media

Wire-mesh media consists of stainless steel, epoxy-coated wire mesh available in 3 mesh sizes:

- 100 mesh yields 150 µm filtration
- 200 mesh yields 74 µm filtration
- 325 mesh yields 44 µm filtration

Typically wire-mesh filters will be applied to catch very large, harsh particulate that would rip up a normal filter. You may also find this media useful as a coarse filter in viscous fluid applications.

### HOW IT WORKS



SEM 60X

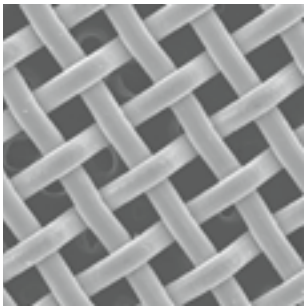

SEM 100X

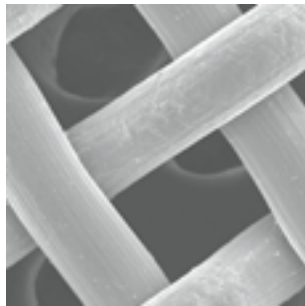

MEDIA IMAGE



## Water Absorbing Media

Water absorption media quickly and effectively removes free water from hydraulic systems. Using super-absorbent polymer technology with a high affinity for water absorption, this media alleviates many of the problems associated with water contamination found in petroleum-based fluids.

### HOW IT WORKS

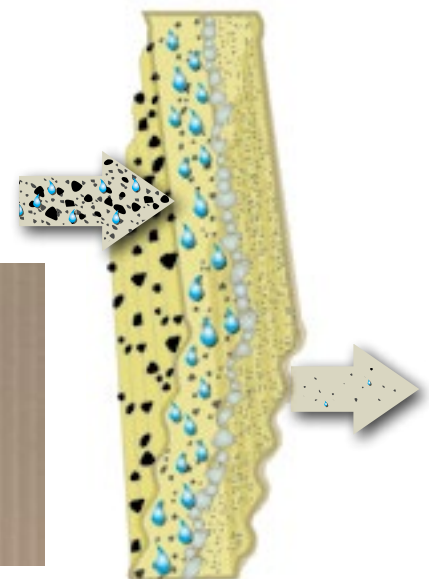

SEM 100X

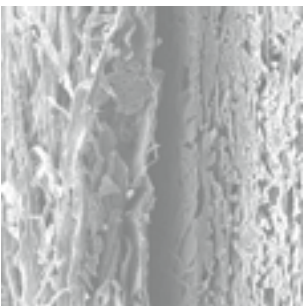

SEM 600X

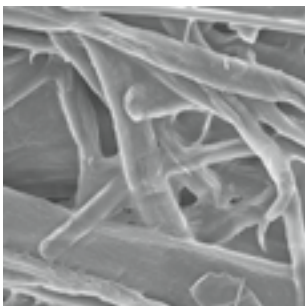

MEDIA IMAGE



## Hydraulic Filtration Pressure Drop

The difference between the inlet pressure and the outlet pressure is called pressure drop or differential pressure. It's symbolized by  $\Delta P$ .  $\Delta P$  is an irrecoverable loss of total pressure caused by the filter, and is mostly due to frictional drag on the fibers in the media.

Differential drop may increase as the particulate rating or efficiency of the filter (as expressed by its beta ratio) gets better.  $\Delta P$  also increases as the filter is being loaded with contaminant.

## Four Major Factors Contribute to Pressure Drop

### 1. Filter Media

Media is, of course, the main factor influencing pressure drop; indeed, it causes pressure drop. That's why having a low-friction, high-flowing media is so important. The natural cellulose or paper fibers (shown at left) typically used in filtration are large, rough, and as irregular as nature made them.

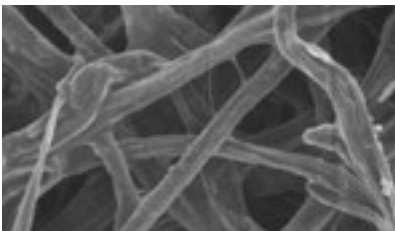

Natural Fiber Cellulose media, as seen under the scanning electron microscope.

Donaldson developed a synthetic media with smooth, rounded fibers, consistently shaped so that we can control the fiber size and distribution pattern throughout the media mat, and still allow the smoothest, least inhibited fluid flow. Our synthetic media is named Synteq™.

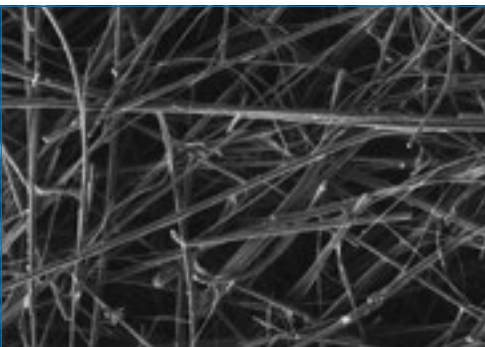

Donaldson's synthetic Synteq filter media — photo from scanning electron microscope — magnified hundreds of times.

Synteq fibers offer the least amount of resistance to fluid passing through the media. Consistency of fiber shape allows the maximum amount of contaminant-catching surface area and specific pore size control. The result is media with predictable filtration efficiencies at removing specified contaminants (i.g., 4  $\mu\text{m}$ ) and maximum dirt holding capacity.

Natural cellulose fibers are larger than synthetic fibers and jagged in shape, so controlling size of the pores in the media mat is difficult and there is less open volume. In most applications this results in higher  $\Delta P$  as compared to synthetic filters. Higher beta ratings mean there are smaller pores in the media; smaller media pores cause more flow resistance, in turn causing higher pressure drop.

### 2. Dirt, Contaminant

As dirt gets caught in the media, it eventually begins to build up and fill the pore openings. As the pore openings shrink, the differential pressure (pressure drop) increases. This is called restriction. This photo from our scanning electron microscope shows actual dirt particles building up in the media pores.

Excessive dirt in the media can cause dirt migration or even filter failure. Dirt migration occurs when the restriction is so great that the differential pressure pushes dirt deeper into the media and, eventually, through the media and back into the system. Filter failure occurs when the restriction becomes so high that the filter cartridge collapses (outside-in flow) or bursts (inside-out flow) to relieve the upstream pressure.

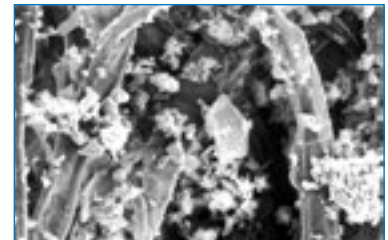

To avoid such catastrophe, use of a filter service indicator is recommended. It measures the pressure drop across the filter, then signals when the filter is 'full' and needs to be changed.

### 3. Flow

Higher flows create higher pressure drop. With fast moving fluid, there will be more friction causing higher pressure drop across the media.

### 4. Fluid Viscosity

Measured in centistokes (cSt) or Saybolt Seconds Universal (SSU or SUS), fluid viscosity is the resistance of a fluid to flow. As fluid viscosity increases, the cSt rating increases. Higher fluid viscosities also mean higher pressure drop because the thicker oil has a tougher time passing through the layer of media fibers. Cold start fluid is a good example of highly viscous fluid. See chart below.

Filter media, amount of contamination, the flow rate, and fluid viscosity are all factors in the importance of sizing the filter for the system requirements. Filters that are too small won't be able to handle the system flow rate and will create excessive pressure drop from the start. The results could be filter operation in the bypass mode, filter failure, component malfunction, or catastrophic system failures. Filters that are too large for the system can be too costly. Oversized filters require more system oil and higher cost replacement filters. Optimal sizing is best.

## Viscosity/Temperature Chart

A.S.T.M. Standard Viscosity-Temperature Chart for Liquid Petroleum Products (D 341-43) Saybolt Universal Viscosity

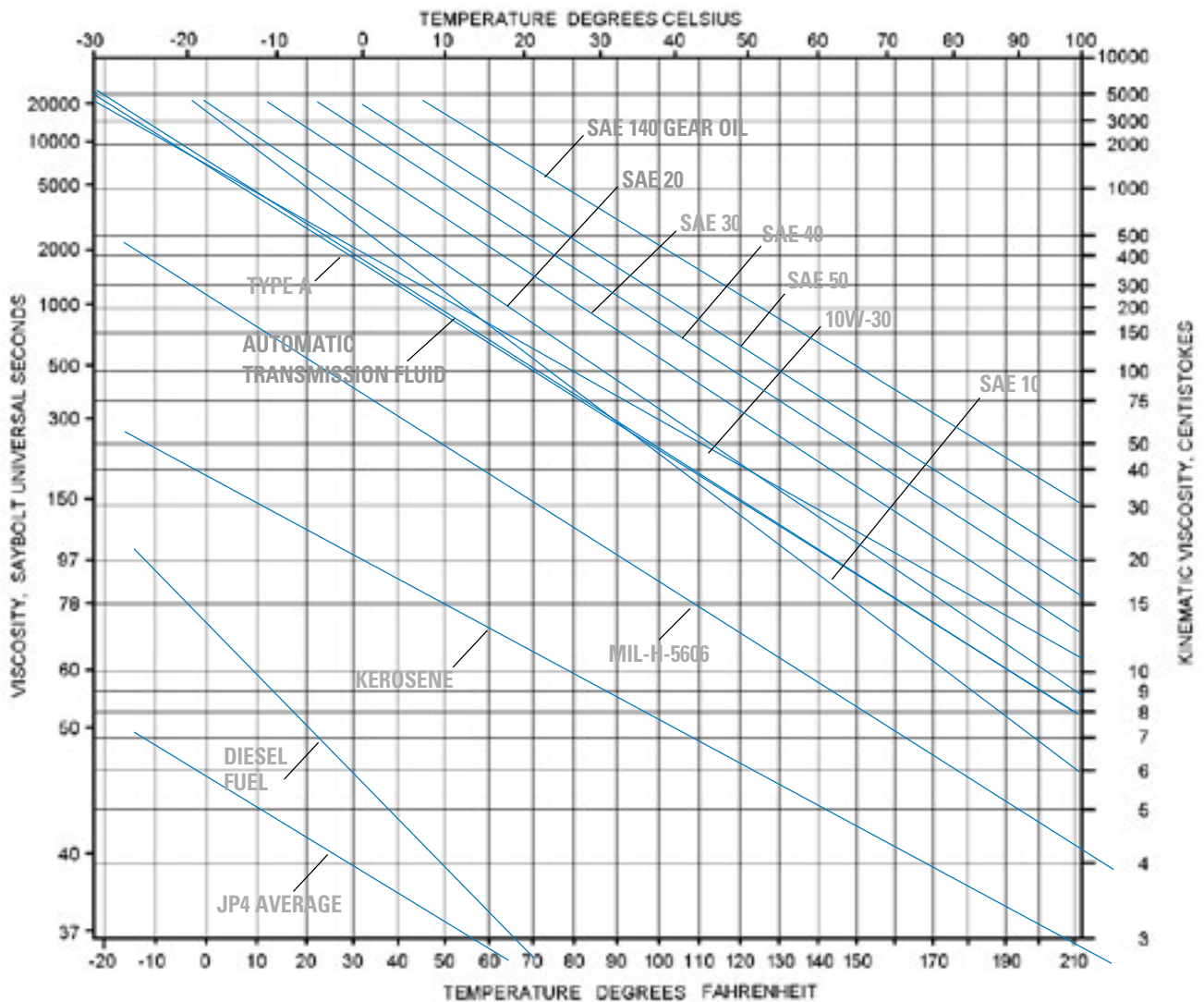

## How Donaldson Displays Filter Flow versus Pressure Loss Data

### Pressure Drop (ΔP) Correction Formulae

To properly calculate pressure loss for viscosity and/or specific gravity, use the filter and housing formulae below to determine the clean filter assembly pressure drop.

#### Filter Correction Calculation

$$\Delta P \text{ Filter} = \Delta P \text{ from graph} \times \frac{\text{New Saybolt Seconds Universal Viscosity (SSU)}}{150} \times \frac{\text{New Specific Gravity (S.G.)}}{.90}$$

- OR -

$$\Delta P \text{ Filter} = \Delta P \text{ from graph} \times \frac{\text{New Centistokes Viscosity (cSt)}}{32} \times \frac{\text{New Specific Gravity (S.G.)}}{.90}$$

#### Clean Filter Assembly Pressure Drop (ΔP) Calculation

$$\Delta P \text{ Clean Filter Assembly} = \Delta P \text{ head} + \Delta P \text{ filter}$$

Filter, Head or Housing/Assembly Reference

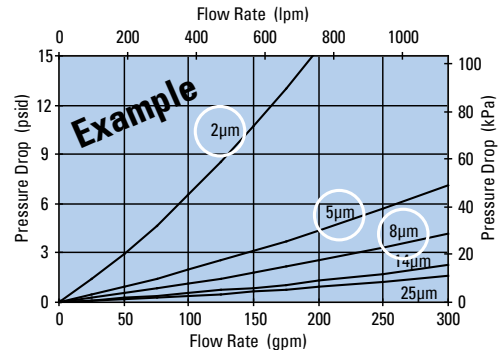

#### Performance Curve Notes

- All flow measurements were made with 32cSt [150 SSU] hydraulic oil at 100°F (37.7°C), fluid specific gravity of 0.9.
- The performance curves displayed are for the filter, head or housing assembly.
- Filter performance curves will either list media numbers or beta ratings (see circled areas on chart above). These labels correspond with the filter choice tables.

## The Importance of Temperature in Determining Pressure Drop

Fluid viscosity plays an important role in restricting the flow through filters. It's crucial to select the proper filter to maintain adequate flow and avoid excessive pressure drops. Measured in centiStokes (cSt) or Saybolt Seconds Universal (SSU or SUS), fluid viscosity is the resistance of a fluid to flow (thickness of fluid). Low viscosity fluids pass through filters with less resistance than high viscosity fluids. Higher fluid viscosities have higher pressure drops due to higher resistance passing through the media. The colder the fluid, the higher the viscosity, so the lowest potential temperature of the fluid is the best measure for calculating pressure drop.

Use the chart below to determine the viscosity of the fluid to be filtered at its lowest potential temperature.

### Oil Kinematic Viscosity Combined With Temperature in centiStokes (cSt)

SAE Gear Oil		75W				80W		85W	90W			140W	
Hydraulic Oil ISO Grade		15	22	32	46	68	100	150	220	320	460	680	
°F	°C												
248°	120°			3.7	3.5	5.7	7.3	9.3	11.7	14.7	18.2	22.9	
230°	110°			4.4	5.5	7.0	9.0	11.7	14.9	18.9	23.7	30.2	
212°	100°	1	4.5	5.4	6.8	8.8	11.4	15.0	19.4	25.0	31.8	41.1	
194°	90°	3	5.3	6.7	8.5	11.2	14.8	19.8	26.0	34.1	44.0	57.9	
176°	80°	5	6.5	8.5	11.0	14.8	19.9	27.1	36.2	48.2	63.3	84.8	
158°	70°	6.2	8.5	11.1	14.8	20.2	27.7	38.5	52.4	71.1	95.2	130	
140°	60°	8	12	15.1	20.6	28.7	40.2	57.2	79.6	110	151	211	
122°	50°	11	15	21.5	29.9	42.9	61.5	98.7	128	181	254	365	
104°	40°	15	22	32	46	68	100	150	220	320	460	680	
86°	30°	21	32	50.7	75.6	116	175	271	409	613	907	1380	
68°	20°	33	51	86.7	135	214	334	536	838	1290	1980	3130	
50°	10°	52	87	162	264	438	711	1190	1920	3070	4870	8020	
32°	0°	85	180	340	585	1020	1720	2990	5060	8400	13900	23900	
14°	-10°	185	375	820	1500	2770	4880	8890	15700	27200	47000	85000	
-4°	-20°	400	800	2350	4650	9120	16800	32300	60000				

## Filter Design and Construction

There are two main differences in a filter. The first is the design of the filter itself, and the second is the type of media that is used in the filter.

### Filter

Filters have some attributes that are immediately obvious to the casual observer, such as height, inside diameter, outside diameter, media concentration, type of liner, seal design, and the way the media and components are glued or potted together.

### Liners

Liners must be structurally sturdy to withstand pressure variance, yet open enough to allow good flow.

### Seals

The top seal design must be leak-free, with a gasket or sealing device that ensures a good seal throughout the life of the filter. Standard seals are made of Buna-N® material, which is fine for most applications. However, if the filtered fluid is diester or phosphate ester fluid, you'll need a seal made of a fluoroelastomer such as Viton®.

Buna-N® and Viton® are registered trademarks of E. I. DuPont de Nemours and Company.

### Media Potting

Media potting is key since it holds the media in place in between the end caps (not visible). Not only should the potting be fully around the ends of the media to prevent leaks, it should also be of a material that can withstand the application. For instance, epoxy potting should be used in filters that must perform in higher temperature environments, phosphate ester fluids and some high water based fluids.



Inside the filter, the media can vary in thickness, pleat depth and pleat concentration.

For example, Donaldson hydraulic filters are generally equipped with either white ("Synteq™" our synthetic material) or natural brown (paper or cellulose material) media. **It is important to note that media colors vary according to each manufacturer – it should not be assumed that any white-colored media is made of synthetic material.**

Some of the most important characteristics of filter media (structure, fiber diameter, volume solidity, basis weight, thickness, layering) can only be detected under a microscope.

### Damaged Equipment

Damage happens when key filtration points are ignored! The pistons in this pump are severely damaged from contamination in the oil.

## Combining the ISO Rating and Filter Performance Ratings

While filter manufacturers publish beta ratings for filter media to describe efficiency performance levels, a direct connection between the beta rating scale and the ISO rating scale cannot be made.

The solution is monitoring filter media performance at removing particles in the 4 µm, 6 µm, and 14 µm ranges. Fluid analysis and field monitoring are the only ways to get these measurements. Combine data from several tests to form a range of performance. Remember, actual filter performance will vary between applications.

Here's how to determine which filter media will best protect your hydraulic components: plot any media performance range on the Application Guide to Donaldson Filter Media (page 158), then connect the dots to make a line. On the same graph, plot your component requirement. (Reference chart below for some popular components, or ask your supplier for the recommended ISO rating.) If the line of the media falls below the ISO line, or if the bottom line of the filtration range does not intersect the ISO line, the component will be protected.

### Micron Sizes of Familiar Particles

Grain of table salt	100 µm
Human hair	80 µm
Lower limit of visibility	40 µm
White blood cell	25 µm
Talcum powder	10 µm
Red blood cell	8 µm
Bacteria	2 µm
Silt	<5 µm

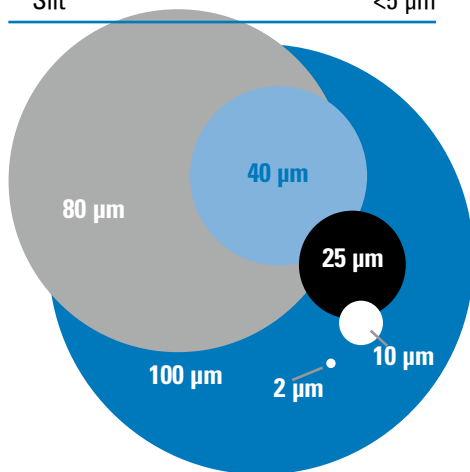

### Typical ISO Cleanliness

Here are some typical ISO cleanliness recommendations from component manufacturers. (These are guidelines; always check the ratings specified by the manufacturer of your specific components.)

Pressure	<3000 PSI ≤ 210 Bar	>3000 PSI >210 Bar
<b>Pumps</b>	--- ISO RATINGS ---	
Fixed Gear Pump	19/17/15	18/16/13
Fixed Vane Pump	19/17/14	18/16/13
Fixed Piston Pump	18/16/14	17/15/13
Variable Vane Pump	18/16/14	17/15/13
Variable Piston Pump	17/15/13	16/14/12
<b>Valves</b>		
Directional (solenoid)	20/18/15	19/17/14
Pressure (modulating)	19/17/14	19/17/14
Flow Controls (standard)	19/17/14	19/17/14
Check Valves	20/18/15	20/18/15
Cartridge Valves	20/18/15	19/17/14
Load-sensing Directional Valves	18/16/14	17/15/13
Proportional Pressure Controls	18/16/13	17/15/12*
Proportional Cartridge Valves	18/16/13	17/15/12*
Servo Valves	16/14/11*	15/13/10*
<b>Actuators</b>		
Cylinders	20/18/15	20/18/15
Vane Motors	19/17/14	18/16/13
Axial Piston Motors	18/16/13	17/15/12
Gear Motors	20/18/15	19/17/14
Radial Piston Motors	19/17/15	18/16/13

\* Requires precise sampling practices to verify cleanliness levels.  
Source: Vickers



## Media Application Guide and ISO Rating System

The Application Guide for Donaldson Filter Media on page 158 provides a data format for rating fluid contamination level and plotting filter media performance.

The vertical numbers on the left side of the chart represent particle counts in a logarithmic progression of ten: .01, .1, 1, 10, 102, 103, 104, 105 and 106. (This represents the number of particle in the oil sample at the given size.) The numbers across the bottom of the chart represent particle size in microns.

Donaldson media efficiency performance levels are derived from the ISO 16889 test standard with NIST-certified on-line automatic particle counters and ISO medium test dust. The Donaldson media efficiency performance levels shown are based on test averages under steady flow conditions. Actual performance levels may vary by application, viscosity, flow variance and contamination differences. Contact Donaldson or your Donaldson distributor for specific application calculations.

The international rating system for fluid contamination levels is called the ISO contamination code and it is detailed in the ISO 4406 document. Most component manufacturers publish filtration level recommendations using the ISO code. The ISO code, located on the right side of the media application guide on page 158, is easy to use if you remember the 4 µm, 6 µm and 14 µm numbers along the bottom of the chart.

Manufacturer's ISO contamination levels are based on controlling the particle counts of 4 µm, 6 µm and 14 µm particles in hydraulic system oil. This level is identified by measuring the number of particles 4µm and greater, 6 µm

### ISO 4406 Contamination Code

#### Range of number of particles per milliliter:

Code	More Than	Up to & Including
24	80,000	160,000
23	40,000	80,000
22	20,000	40,000
21	10,000	20,000
20	5,000	10,000
19	2,500	5,000
18	1,300	2,500
17	640	1,300
16	320	640
15	160	320
14	80	160
13	40	80
12	20	40
11	10	20
10	5	10
9	2.5	5
8	1.3	2.5
7	.64	1.3
6	.32	.64

and greater, and 14 µm and greater in one milliliter of the system hydraulic oil sample.

### How to Use the ISO Rating

**Example:** A cartridge valve manufacturer recommends an ISO cleanliness level of 18/16/13.

- 1) On the Application Guide for Donaldson Filter Media on page 158, place a dot on the vertical 4 µm line, horizontally even with the 18 box of the ISO code.
- 2) Place a dot on the vertical 6 µm line horizontally even with the 16 box of the ISO code.
- 3) Place a dot on the vertical 14 µm line horizontally even with the 13 box of the ISO code.
- 4) Connect the dots to get the ISO cleanliness level 18/16/13.

As illustrated below, particle counts falling on and above the 18/16/13 line are damaging to the component and exceed the 18/16/13 specification set by the manufacturer.

Select a Donaldson media that falls below 18/16/13 to achieve cleanliness level tolerable to the component.

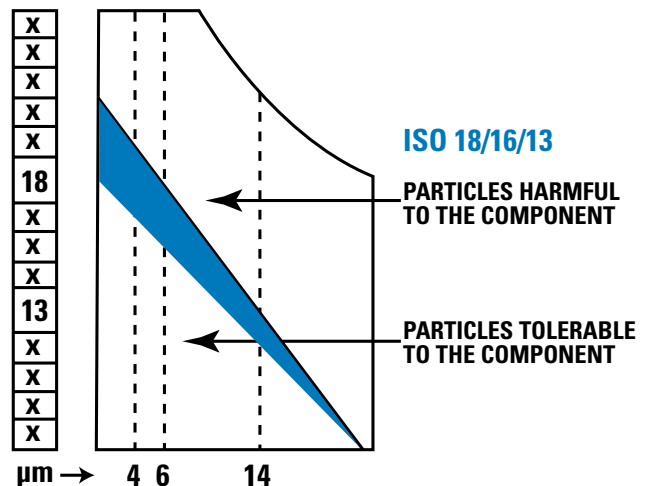

## Filter Efficiency Standards

### Understanding the Beta Rating System

This information is provided as an aid to understanding fluid filter efficiency terminology based on current ISO, ANSI and NFPA test standards. It is not proprietary and may be reproduced or distributed in any manner for educational purposes.

### What is Beta Ratio?

Beta ratio (symbolized by  $\beta$ ) is a formula used to calculate the filtration efficiency of a particular fluid filter using base data obtained from multi-pass testing.

In a multi-pass test, fluid is continuously injected with a uniform amount of contaminant (i.e., ISO medium test dust), then pumped through the filter unit being tested. Filter efficiency is determined by monitoring oil contamination levels upstream and downstream of the test filter at specific times. An automatic particle counter is used to determine the contamination level. Through this process an upstream to downstream particle count ratio is developed, known as the beta ratio. The formula used to calculate the beta ratio is:

$$\text{Beta ratio}_{(x)} = \frac{\text{particle count in upstream oil}^*}{\text{particle count in downstream oil}^*}$$

where (x) is a given particle size

\* off all particles of size x and bigger

Indicates that testing was done with APC's calibrated with NIST fluid

$$\beta_{10(c)} = 1000$$

1000 times more particles upstream than downstream that are 10  $\mu\text{m}$  and larger

### Why the Efficiency Rating Test Standard was Updated

The International Industry Standard (ISO) for multi-pass testing provides a common testing format for filter manufacturers to rate filter performance. This standardization gives you the ability to reliably compare published filter ratings among different brands of filters.

ISO test standards were updated in 1999 to reflect the improved technology available in particle counters and other test equipment. The newer particle counters provide more precise counting and greater detail – reflecting a truer indication of filter performance.

The National Fluid Power Association (NFPA), the National Institute of Standards & Technology (NIST), and industry volunteers, including several engineers from Donaldson, helped revise the ISO standard. ISO 16889 has been in force since late 1999 and ISO 4572 is officially discontinued.

### Better Test Dust

The old test dust (AC fine test dust or ACFTD) was “ball milled,” which produced dust particles of varying size and shape. Particle distribution was often different from batch to batch. The accuracy of ACFTD distribution and previous APC calibration procedure was questioned by industry, due to lack of traceability and certification. ACFTD hasn't been produced since 1992.

Now, the new test dust (ISO medium test dust) is “jet milled” to produce consistent particle size, shape, and distribution from batch to batch. See dust size comparison chart below.

### Liquid Automatic Particle Counters (APC's)

In the old test standard (ISO 4572), fluid samples obtained in bottles and off-line particle counting were allowed. Now, in the updated standard (ISO 16889), on-line, laser-based automatic particle counters, especially made for measuring liquids, are required and bottle counting methods are disallowed, as illustrated on next page.

Find further information on ISO 16889 at [www.NFPA.com](http://www.NFPA.com) or your ISO document source. Ask for ISO/TR16386: 1999 “The Impact of Changes in ISO Fluid Power Particle Counting – Contamination Control and Filter Test Standards.”

The old particle counter calibration was based on only one dimension of an irregularly-shaped particle (the longest cord). Today, the particle counter calibration is based on equivalent spherical area of an irregularly-shaped particle.

NIST provides calibration suspension, which is certified with X number of particles at a certain size. This is verified by NIST. The new way to list beta ratios includes a subscript (c) to indicate NIST certified test suspension and assures you of traceability and repeatability.

Overall, you can have strong confidence in filter ratings resulting from tests per ISO 16889, as they are highly accurate. As always, keep in mind that beta ratings are laboratory measurements under steady flow conditions with artificial contaminants – the real proof of the performance is how clean the filter keeps

the fluids in the application. A good oil analysis program that checks the cleanliness of the oil periodically will verify that the proper filters are being used.

## Test Dust Size Comparisons

ACFTD calibrated size (µm) per ISO 4402 corresponds to a NIST-calibrated size [µm(c)] per ISO 11171

ACFTD	0.8	1	2	2.7	3	4.3	5	7	10	12	15	15.5	20	25	30	40	50
NIST	4	4.2	4.6	5	5.1	6	6.4	7.7	9.8	11.3	13.6	14	17.5	21.2	24.9	31.7	38.2

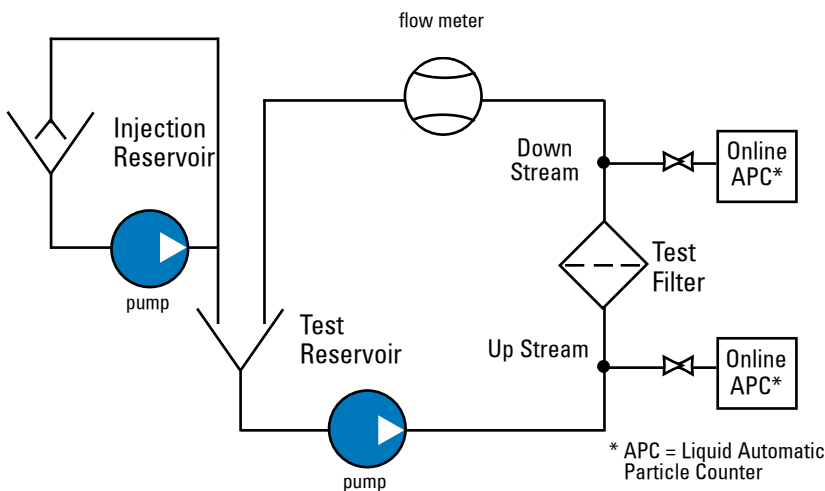

## ISO 16889

- In-Line Liquid Automatic Particle Counters (APC) are now required for proper testing.
- APC calibration follows ISO 11171 procedures
- ISO 11171 uses NIST (National Institute of Standards & Technology) certified calibration fluid

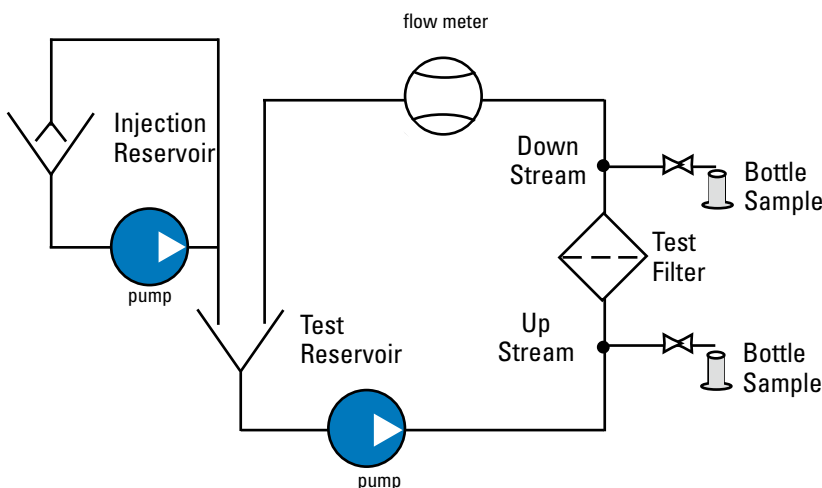

## ISO 4572 (Discontinued)

- Either bottle samples or APC's were allowed.
- APC calibration followed ISO4402 ACFTD (Discontinued)

## Highlights of ISO 16889

- ISO 4572 is now replaced by ISO 16889 as the international standard for Multi-Pass Tests to determine the efficiency (beta rating or beta ratio) and the dirt-holding capacity of the filter.
- The test bench for ISO 16889 must have On-Line Liquid Automatic Optical Particle Counters (APC) calibrated using NIST (National Institute of Standards & Technology)-certified calibration fluid. This includes added enhancements to APC's, to allow for better resolution, accuracy, repeatability and reproducibility.
- ISO 12103-1,A3 (ISO Medium, 5µm-80µm)
- Test Dust was selected as replacement dust for calibration and testing procedures.
- APC's are calibrated by passing a sample of calibration fluid with a known particle size distribution and producing a calibration curve to match the known count distribution.
- NIST used the Scanning Electron Microscope analysis and statistical analysis techniques to certify the particle size distribution.
- Particle counts, upstream and downstream, are taken every minute of the test.
- Beta ratios are reported with (c) to designate NIST traceability.

## ISO 16889 recommends reporting beta ratings at:

Rating	Efficiency
2	50%
10	90%
75	98.7%
100	99%
200	99.5%
1000	99.9%

Example:  $\beta_4(c) = 200$  signifies that there are 200 times as many particles that are 4 µm and larger upstream as downstream. This is 99.5% efficiency.

Example:  $\beta_5(c) = 1000$  indicates that there are 1000 times as many particles that are 5 µm and larger upstream as downstream. This is 99.9% efficiency.

## Donaldson Hydraulic Filter Media Beta Ratings

Donaldson hydraulic filter media beta ratings are average ratings obtained from multi-pass tests performed per the new ISO 16889 standard.

According to the ISO standard, each filter manufacturer can test a given filter at a variety of flow rates and terminal pressure drop ratings that fit the application, system configuration and filter size. Your actual performance may vary depending on the configuration of the filter tested and test conditions.

NEW Donaldson Filter Media Efficiency Ratings per ISO 16889 Test Standards		
Media No	Former Rating	Efficiency Rating
	Beta x µm = 2/75 per ISO 4572	Beta x µm(c) = 200/1000 per ISO 16889
Donaldson Synteq® XP Synthetic Media		
XP05		5/7
XP10		9/11
Donaldson Synteq® Synthetic Media		
# 7	7/22	25/33
# 20	20/40	42/>50
/00	<2/3	5/6
/03	7/22	18/23
Donaldson Cellulose Media		
# 10	10/25	19/23
/1	10/30	32/36
/3	25/45	46/>50

## Cleanliness Level Correlation Table

Conversion of cleanliness specifications to filter performance is not an exact science because the contamination level in a hydraulic system is a function of the ingress and generation rate as well as the filter performance.

### Factors That Affect Cleanliness Levels in a Hydraulic System

- Abrasive wear in space between adjacent moving surfaces of components.
- Erosive wear at component edges or direction changes where there is high fluid velocity.
- Fatigue wear by particles trapped between moving surfaces.

### Identification of the Most Sensitive Component

- Required cleanliness level is dominated by the component with smallest clearances and/or highest loading on the lubricating film.
- Best source for determining this level is the specification published by the component manufacturer.
- Higher pressures reduce component life, unless contamination level is decreased accordingly.
- Operating at half the rated pressure of component will increase its life by more than four times.
- Percent of operating time at maximum pressure depends on individual machines and application.

ISO Code	Particles Per Milliliter >10 microns	ISO FTD* Gravimetric Level (mg/l)	Mil Std 1236A (1967)	NAS 1638 (1964)	SAE Level (1963)
30/26/23	140,000	1000			
29/25/23	85,000		1000		
26/25/20	14,000	100	700		
23/21/18	4,500			12	
2220/18	2,400		500		
22/20/17	2,300			11	
21/20/17	1,400	10			
21/19/16	1,200		10		
20/18/15	580			9	6
19/17/14	280		300	8	5
18/16/13	140	1		7	4
17/15/12	70			6	3
16/14/12	40		200		
16/14/10	35			5	2
15/13/10	14	0.1		4	1
14/12/9	9			3	0
13/11/8	5			2	
12/10/8	3		100		
12/10/7	2.3			1	
11/10/6	1.4	0.01			
11/9/6	1.2			0	
10/8/5	0.6			0	
9/7/5	0.3		50		
8/6/3	0.14	0.001			
7/5/2	0.04		25		
6/2/8	0.01		10		

\* SAE Fine Test Dust – ISO approved test and calibration contaminant. Source: Milwaukee School of Engineering Seminar, Contamination & Filtration of Hydraulic Systems

Cleanliness Code ISO 4406: 1999	System type	Suggested Efficiency ISO 16889	Suggested media
15/13/10	servo-valves for pressure >20MPa, laboratory & aerospace	$\beta$ 2 $\mu$ m(c) = 200	/00
14/16/11	high perf. & high press. long life components, i.e. small gearbox	$\beta$ 2 $\mu$ m(c) = 200 $\beta$ 5 $\mu$ m(c) = 200	/00 XP5
17/15/12	i.e. servo-valves, general power transmission gearbox	$\beta$ 7 $\mu$ m(c) = 200	XP5
18/16/13	high quality reliable, general purpose mach., vane & piston pumps, prop. valves, large gearbox	$\beta$ 7 $\mu$ m(c) = 200 $\beta$ 10 $\mu$ m(c) = 200	XP5 XP10
19/17/14	gear pumps	$\beta$ 10 $\mu$ m(c) = 200 $\beta$ 12 $\mu$ m(c) = 200	XP10
20/18/15	mobile equipment, medium pressure i.e. motors, valves & control	$\beta$ 12 $\mu$ m(c) = 200 $\beta$ 15 $\mu$ m(c) = 200	XP10
21/19/16	low-medium pressure systems, heavy industry, cylinders, steering unit (load sens.)	$\beta$ 15 $\mu$ m(c) = 200 $\beta$ 20 $\mu$ m(c) = 200	/03
22/20/17	low pressure systems	$\beta$ 25 $\mu$ m(c) = 200	/03
23/21/18	low pressure systems with large clearance	$\beta$ 25 $\mu$ m(c) = 200 $\beta$ 10 $\mu$ m(c) = 2	/03 /1 # 10
26/24/20	low pressure systems with large clearance	$\beta$ 40 $\mu$ m(c) = 200 $\beta$ 23 $\mu$ m(c) = 2	/3 # 20

## Compatibility of Donaldson Filter Media with Hydraulic Fluids

While Donaldson has developed many formulations of media, they can be divided into two broad categories: natural fibers, usually cellulose, and synthetic or man-made fibers.

Petroleum-Based (Hydrocarbon) Fluids	Recommended Filter Media		
	Cellulose	Synteq	DT Synteq
Straight oils	Yes	Yes	Yes
ATFs	Yes	Yes	Yes
Military hydraulic fluids	Yes	Yes	Yes
#2 Diesel fuel	Yes	Yes	Yes
Gasoline	Yes	Yes	Yes
E85 (85/15 Ethanol/Gasoline)	No	No	Yes
Fire Resistant Fluids	Cellulose	Synteq	DT Synteq
HFA - Oil-in-water emulsion	No	<150°F	Yes
HFB - Water-in-oil emulsion	No	<150°F	Yes
HFC - Water glycol	No	<150°F	Yes
HFD Synthetics - Polyol esters, Esters, Diesters, & blends	No	Yes	Yes
HFD Synthetics - Phosphate esters	No	No	Yes
HFD Synthetics - Polyalkylene glycols (PAG), Polyalphaolefins (PAO), & blends	No	Yes	Yes
HFD Synthetics - Silicone (siloxane) oil	No	Yes	Yes
Biodegradable Fluids	Cellulose	Synteq	DT Synteq
Vegetable-based oils - sunflower, rapeseed oils	No	Yes	Yes
Synthetic oils - PAG / PAO	No	Yes	Yes
Synthetic oils - Esters, Diesters	No	Yes	Yes



### Piston Pump Damage

The severe score marks on the piston slippers leave no question about why good hydraulic filtration is important.

## Threads

- Gas per ISO 228/1
- M per UNI 4534-5545
- Flange connections per SAE J518 3000 PSI or 6000 PSI
- UN-UNC-UNF-UNS per ANSI/ASME B1.1
- SAE per SAE J1926-1
- NPT per ANSI/ASME 1.20.1
- NPTF per ANSI/ASME 1.20.3



Donaldson.  
FILTRATION SOLUTIONS

# Donaldson Engine E-Catalogues

Check out Donaldson's Engine E-catalogue by clicking or browsing to one of the below links:

[www.donaldson-catalogue.com/air](http://www.donaldson-catalogue.com/air)

[www.donaldson-catalogue.com/hydraulic](http://www.donaldson-catalogue.com/hydraulic)

[www.donaldson-catalogue.com/liquid](http://www.donaldson-catalogue.com/liquid)

[www.donaldson-catalogue.com/agriculture](http://www.donaldson-catalogue.com/agriculture)

[www.donaldson-catalogue.com/truckBus](http://www.donaldson-catalogue.com/truckBus)

[www.donaldson-catalogue.com/forklift](http://www.donaldson-catalogue.com/forklift)

[www.donaldson-catalogue.com/exhaust](http://www.donaldson-catalogue.com/exhaust)



An E-Catalogue is an interactive format of a standard pdf with handy search functions. No password required!

REMARK: If the E-Catalogue doesn't open, it means that Adobe Flash Player is not installed on your computer.

# Mix&Match

Your flexible hydraulic filtration solutions

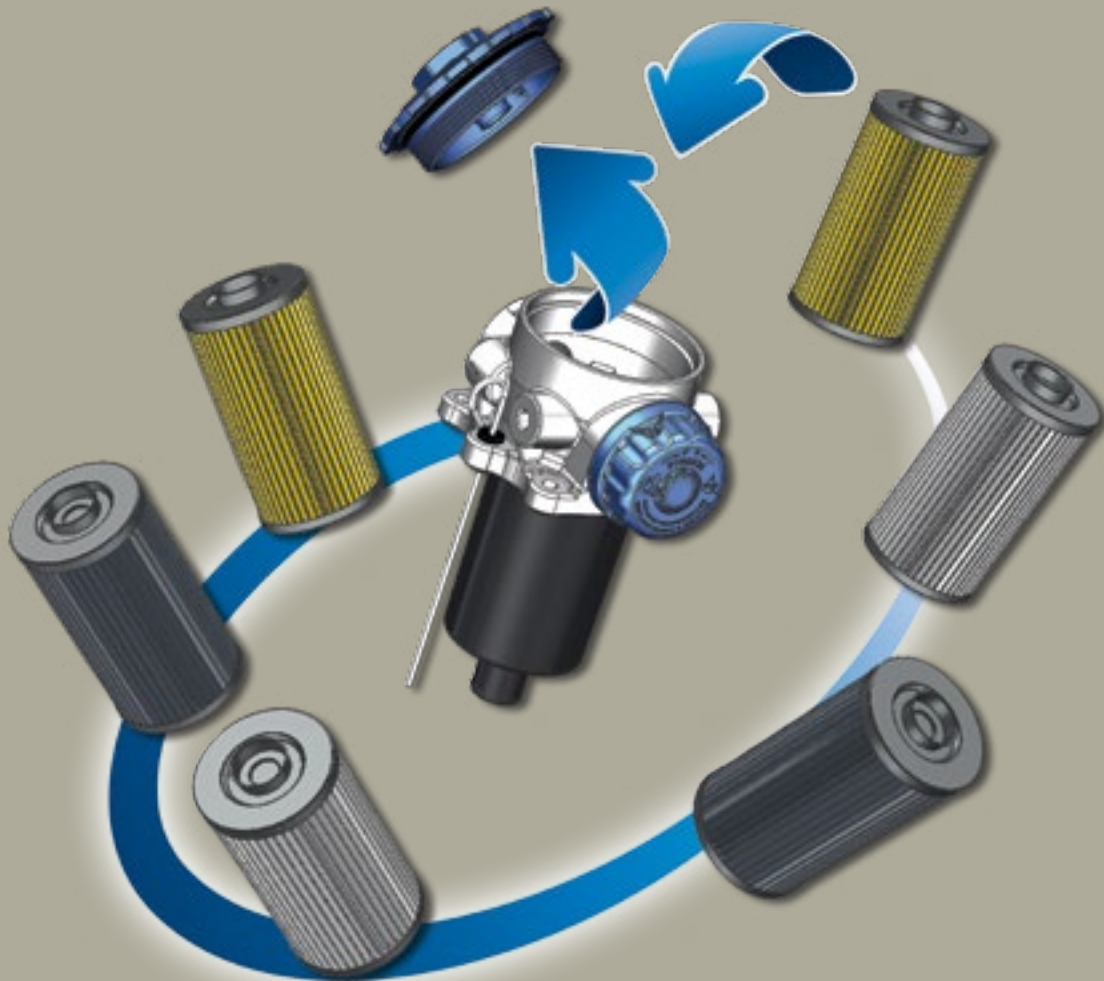

**Donaldson**  
FILTRATION SOLUTIONS

## EUROPEAN HEADQUARTERS

Donaldson Europe B.V.B.A. / Phone +32 16 38 38 11

## OFFICES

Donaldson France S.A.S / Bron - France  
Phone +33 47 21 41 840

Donaldson Ibérica, Soluciones en Filtración, S.L. / Madrid - Spain  
Phone +34 91 676 86 68

Donaldson Filter Components Ltd. / Hull - UK  
Phone +44 14 82 83 52 13

Donaldson Filtration Deutschland GmbH / Dülmen - Germany  
Phone +49 2594 78153 / +49 2594 78126

Donaldson Italia SRL / Ostiglia (Mantova) - Italy  
Phone +39 0386 30211

Donaldson Sweden / Bromma - Sweden  
Phone +46 8 471 8660

Donaldson Filtre Sist. Tic. Ltd. / Istanbul - Turkey  
Phone +90 (212) 244 73 31

Donaldson CZ/PL/SK/ Warszawa - Poland  
Phone +420 773 795798

Donaldson rep office Bulgaria / Sofia, Bulgaria  
Phone +359 2 4914050

Donaldson Czech Republic / Klasterec - Czech Republic  
Phone +420 (0) 474319921

Representative office of Donaldson Nederland B.V. / Moscow - Russia  
Phone +7 499 13 600 13



Scan for digital  
**Mix&Match catalogue**

[Engine-europe@donaldson.com](mailto:Engine-europe@donaldson.com)  
[www.donaldson.com](http://www.donaldson.com)

**European Technical Hydraulic Catalogue  
F116091, extract of F116023 (12/14)**